

# ATOM™ diagnostic kit



# Contents

	Page
<b>1. General information</b>	3
1.1. Minimum system requirements	3
1.2. General specifications	3
1.3. Product compliance	3
1.4. Kit contents	4
1.5. Dongle dimensions	5
1.6. Dongle interface dimensions	5
1.7. Signals	5
<b>2. Software installation</b>	6
<b>3. Using Renishaw's ATOM diagnostic software</b>	6
3.1. Connecting the system	7
3.1.1. ATOM with digital Ti interface	7
3.1.2. 15 way D-type ATOM readhead	7
3.1.3. Cabled ATOM readhead	7
3.1.4. FPC ATOM readhead	8
3.2. Starting the software	9
3.3. Using the software	10
3.3.1. Signal size	10
3.3.2. Reference mark phasing	11
3.3.3. CAL button	11
3.3.4. AGC button	12
<b>4. Faultfinding</b>	13
4.1. Driver installation failure	13
4.2. Communication error	13
4.3. Calibration failure	14
<b>5. Hardware driver installation</b>	15
5.1. Automatic driver installation	15
5.2. Manual hardware driver installation	15
<b>6. Repairing/uninstalling the software</b>	15

## 1. General information

### 1.1. Minimum system requirements

- Microsoft Windows 8, Windows 7 or Windows XP
- Microsoft.NET Framework 4.0 Full
- USB port
- Internet connection for software download

### 1.2. General specifications

<b>Power supply</b>	5 V $\pm$ 10%	The dongle can be powered from the USB port or an external 5 V dc supply with the requirements for SELV or standard IEC/BS/EN 60950-1. Dongle current consumption <50 mA Dongle interface current consumption <100 mA Ripple <200mVpp maximum at frequency up to 500 KHz
<b>Temperature</b>	Storage Operating	-20 °C to +70 °C 0°C to +70 °C
<b>Humidity</b>		Rated up to 40 °C, 95% relative humidity (non-condensing)
<b>Sealing</b>		IP20

### 1.3. Product compliance

Renishaw plc declares that ATOM diagnostic kit complies with the applicable standards and regulations. A copy of the EC Declaration of Conformity is available on request.

#### FCC compliance

This device complies with part 15 of the FCC Rules. Operation is subject to the following two conditions: (1) This device may not cause harmful interference, and (2) this device must accept any interference received, including interference that may cause undesired operation.

The user is cautioned that any changes or modifications not expressly approved by Renishaw plc or authorised representative could void the user's authority to operate the equipment.

This equipment has been tested and found to comply with the limits for a Class A digital device, pursuant to part 15 of the FCC Rules. These limits are designed to provide reasonable protection against harmful interference when the equipment is operated in a commercial environment. This equipment generates, uses, and can radiate radio frequency energy and, if not installed and used in accordance with the instruction manual, may cause harmful interference to radio communications. Operation of this equipment in a residential area is likely to cause harmful interference in which case the user will be required to correct the interference at his own expense.

**NOTE:** This unit was tested with shielded cables on the peripheral devices.  
Shielded cables must be used with the unit to ensure compliance.

#### RoHS compliance

Compliant with EC directive 2011/65/EU (RoHS)

#### Further information

Further information relating to the ATOM encoder range can be found in the ATOM system Data sheet and Installation guides. These can be downloaded from our website [www.renishaw.com/encoder](http://www.renishaw.com/encoder) and are also available from your local representative. This document may not be copied or reproduced in whole or in part, or transferred to any other media or language, by any means without the written prior permission of Renishaw. The publication of material within this document does not imply freedom from the patent rights of Renishaw plc.

#### Disclaimer

RENISHAW HAS MADE CONSIDERABLE EFFORTS TO ENSURE THE CONTENT OF THIS DOCUMENT IS CORRECT AT THE DATE OF PUBLICATION BUT MAKES NO WARRANTIES OR REPRESENTATIONS REGARDING THE CONTENT. RENISHAW EXCLUDES LIABILITY, HOWSOEVER ARISING, FOR ANY INACCURACIES IN THIS DOCUMENT.



The use of this symbol on Renishaw products and/or accompanying documentation indicates that the product should not be mixed with general household waste upon disposal. It is the responsibility of the end user to dispose of this product at a designated collection point for waste electrical and electronic equipment (WEEE) to enable reuse or recycling. Correct disposal of this product will help to save valuable resources and prevent potential negative effects on the environment. For more information, please contact your local waste disposal service or Renishaw distributor.

## 1.4. Dongle kit contents

- A-9411-0011:

Item	Description	Quantity
1	Dongle	1
2	Dongle interface	1
3	USB cable	1
4	Interface cable for ATOM 15 way D-type readheads	1
5	Interface cable for ATOM and TONiC readheads	1
6	Sacrificial interconnect PCB for ATOM and TONiC cabled readheads	10
7	Sacrificial interconnect PCB for FPC readheads	10

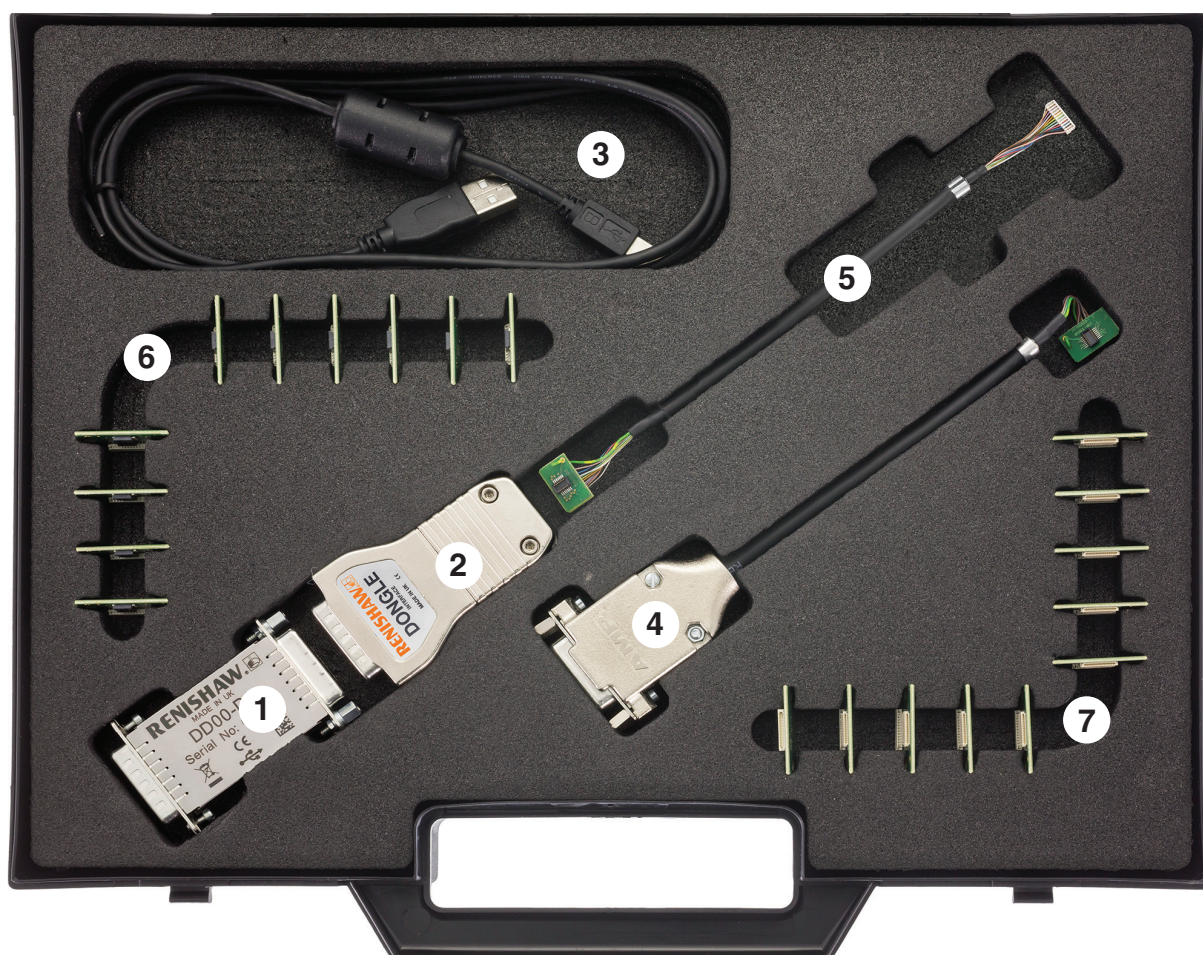

The dongle/Ti interface connector is not designed for multiple insertions and removals. The sacrificial interconnect PCB's should be used and replaced when worn or damaged.

Packs of 10 replacement PCB's are available to order:

Item 6: A-9411-0016

Item 7: A-9411-0017

### 1.5. Dongle dimensions

Dimensions and tolerances in mm

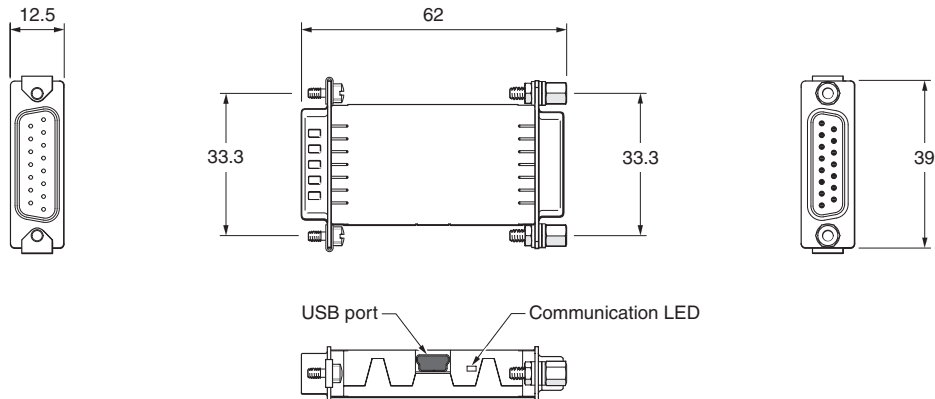

### 1.6. Dongle interface dimensions

Dimensions and tolerances in mm

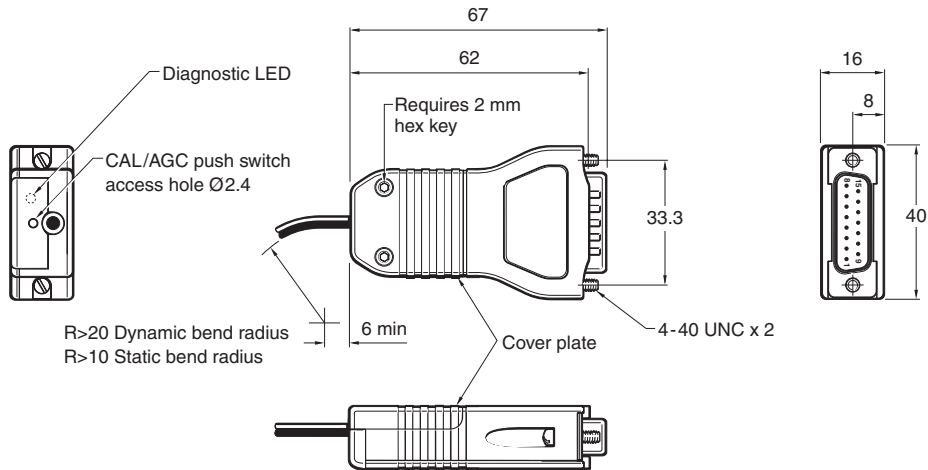

### 1.7. Signals

Function	Signal	Dongle interface		Dongle	
		Output pin (male 15 way D-type)	Input pin (female 15 way D-type)	Output pin (male 15 way D-type)	
Power	5 V	7, 8	7, 8	7, 8	
	0 V	2, 9	2, 9	2, 9	
Incremental	A	+	14	14	14
		-	6	6	6
	B	+	13	13	13
		-	5	5	5
Reference mark	Z	+	12	12	12
		-	4	4	4
Alarm	E	+	11	11	11
		-	3	3	3
External set-up	X	1	1	-	
Shield	Inner screen	15	15	15	
Do not connect	-	10	10	1, 10	

## 2. Software installation

**Full administration rights are necessary to install and uninstall the ATOM hardware drivers and software.**

Before installing a new version of the ATOM software ensure that any previous versions have been uninstalled.  
(See section 6 'Repairing/uninstalling the software' for more information).

- Download the **ATOM diagnostic software** installation file from the 'Software download' section on [www.renishawsupport.com](http://www.renishawsupport.com)
- It will ask 'Do you want to run or save ATOM Installer.exe from renishaw.com?'
- Click **Run**.
- The InstallShield Wizard will start automatically.
- Follow the instructions on the screen and the installation program will automatically run through the installation process.

**NOTE:** On Windows 8 it will ask :

'Do you want to allow the following program from an unknown publisher to make changes to this computer ?'  
Click **Yes** to continue the installation.

- Once the software installation has completed click **Finish** to close the window.
- The software will have installed an icon on the desktop.



## 3. Using Renishaw's ATOM diagnostic kit

The ATOM diagnostic kit can be used to connect the ATOM system, via a USB link, to a PC to assist with the set-up.

The software displays:

- Signal size
- Reference mark phasing

It also allows system calibration to be initiated and Automatic Gain Control (AGC) to be toggled.

The dongle can be powered via the USB connection or in-line with the customers' electronics.

### 3.1. Connecting the system

Choose the appropriate interconnect cabling for your system from the options below and connect the ATOM readhead to the dongle.

Readhead	Interface	Section
ATOMxTx	Ti0004 – Ti4000 only	3.1.1
ATOMxTx	ACi Ri Ti10KD and Ti20KD	3.1.3
ATOMxDx	–	3.1.2
ATOMxFx	ACi	3.1.4

#### 3.1.1. ATOM (ATOMx Tx) with a digital Ti interface (Ti0004 - Ti4000)

Only for ATOM systems connected to a Ti0004 - Ti4000 interface.

- Items required for connection:
  - Item 1, dongle
  - Item 3, USB cable
- Connect the ATOM readhead to the Ti interface. See the relevant ATOM installation guide for details of connecting the readhead to the Ti interface (System connection: Ti interface).
- Connect the output of the Ti interface to the input of the dongle.
- If using the diagnostic dongle 'in-line' connect the output of the dongle to the customers controller.
- Proceed to section 3.2. 'Starting the software'



#### 3.1.2. 15 way D-type ATOM readhead (ATOMx Dx)

- Items required for connection:
  - Item 4, Interface cable for ATOM 15 way D-type readheads
  - Item 2, dongle interface
  - Item 1, dongle
  - Item 3, USB cable

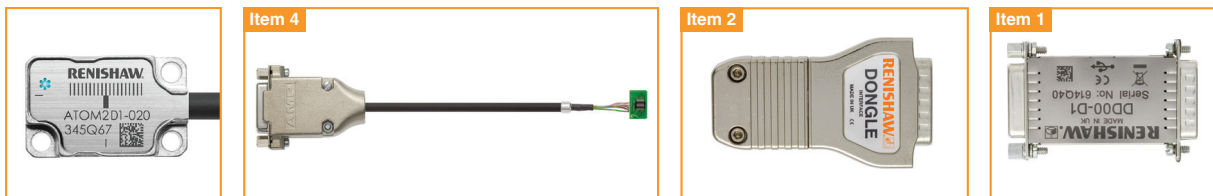

- Connect the 15 way D-type from the ATOM readhead to the interface cable (Item 4)
- Open the cover plate on the dongle interface (Item 2) and connect the mini PCB into the interface.  
See the relevant ATOM installation guide for details of connecting the readhead to the dongle interface (System connection: Ti interface)
- Connect the output of the dongle interface to the input of the dongle (Item 1)
- Proceed to section 3.2 'Starting the software'.

### 3.1.3. Cabled ATOM readhead (ATOMx Tx)

For cabled ATOM readheads used with ACi, Ri or Ti10KD/20KD interfaces

- Items required for connection:
  - Item 6, sacrificial interconnect PCB for cabled readhead
  - Item 5, Interface cable for ATOM readheads
  - Item 2, dongle interface
  - Item 1, dongle
  - Item 3, USB cable

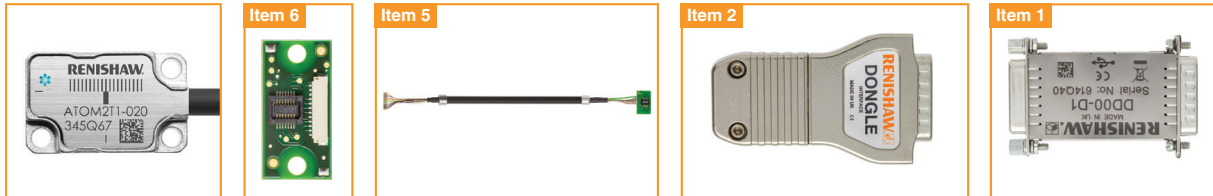

- Do not connect the readhead to the interface.
- Connect the sacrificial interconnect PCB to the JST connector on the interface cable (Item 5).
- Connect the mini PCB on the cabled ATOM readhead to the sacrificial interconnect PCB for cabled readheads (Item 6) Ensure correct orientation of the connector, both cables will come out of the same side of the pcb.
- Open the cover plate on the dongle interface (Item 2) and connect the mini PCB into the interface. See the relevant ATOM installation guide for details of connecting the readhead to the dongle interface (System connection: Ti interface).
- Connect the output of the dongle interface to the input of the dongle (Item 1).
- Proceed to section 3.2 'Starting the software'.

**NOTE:** The dongle interface connector is not designed for multiple insertions and removals.  
The sacrificial interconnect pcbs should be used and replaced when worn or damaged.

### 3.1.4. FPC ATOM readhead

- Items required for connection:
  - Item 7, sacrificial interconnect PCB for FPC readheads
  - Item 5, Interface cable for ATOM readheads
  - Item 2, dongle interface
  - Item 1, dongle
  - Item 3, USB cable

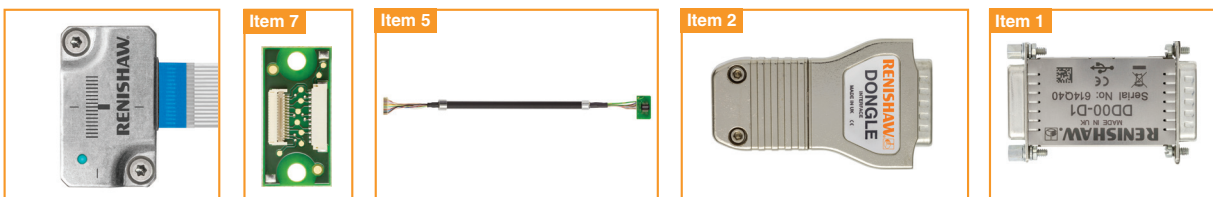

- Do not connect the ACi interface.
- Connect the FPC cable from the ATOM readhead to the sacrificial interconnect PCB for FPC readheads (Item 7). See the relevant ATOM installation guide for details of connecting the FPC (System connection: Inserting the FPC cable).
- Connect the sacrificial interconnect PCB to the JST connector on the interface cable (Item 5).
- Open the cover plate on the dongle interface (Item 2) and connect the mini PCB into the interface. See the relevant ATOM installation guide for details of connecting the readhead to the dongle interface (System connection: Ti interface).
- Connect the output of the dongle interface to the input of the dongle (Item 1).
- Proceed to section 3.2 'Starting the software'.

**NOTE:** The sacrificial interconnect pcbs should be replaced when worn or damaged.



### 3.2. Starting the software

ON FIRST USE DO NOT CONNECT THE SYSTEM TO THE USB PORT BEFORE STARTING THE SOFTWARE

On first use the software will automatically install the hardware drivers, see section 5 'Hardware driver installation' for more information.

- Double click on the '**ATOM DIAGNOSTIC**' icon on the desktop.
- The software will open a 'greyed out' window displaying the 'Start page' with an orange circle saying 'Please connect to device' indicating that it is waiting for the ATOM system to be connected.
- Using the USB cable (item 3) connect the dongle via the USB port to the PC.  
See section 3.1 'Connecting the system' for details on connecting the ATOM readhead to the dongle.



- The 'Start page' will then become active.
  - The PSU voltage will display USB showing it is powered via the USB port or the supply voltage if used 'in-line'
  - The diagnostic LED on the dongle or Ti interface will now double flash orange and the communication LED on the dongle will be green.
- Click on the green arrow to enter the software.
  - The 'Signal' screen will now be displayed (See section 3.3 'Using the software').
  - The diagnostic LED on the dongle or Ti interface will continue double flashing orange and the communication LED on the dongle will be green.

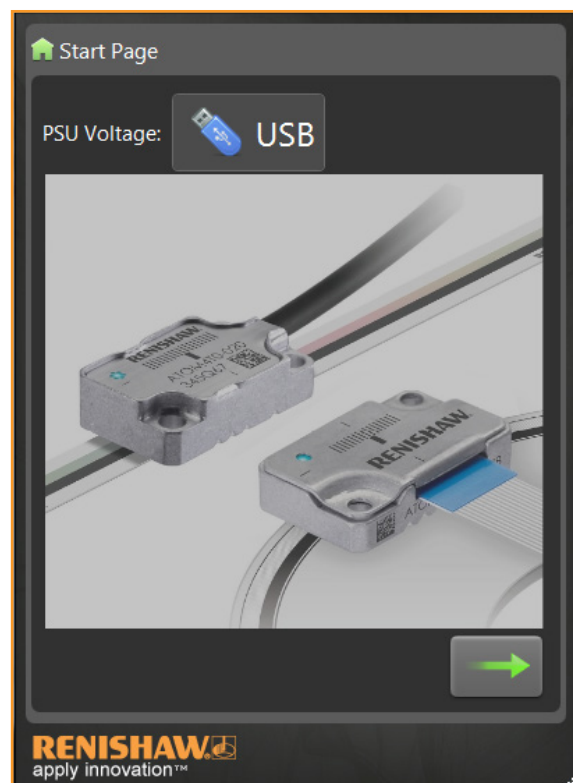

### 3.3. Using the software

This section explains the functions of software. It should be used in conjunction with the relevant ATOM installation guide for details on how to install and set the system up.

Only one copy of the software should be opened at a time with only a single ATOM system connected to it.

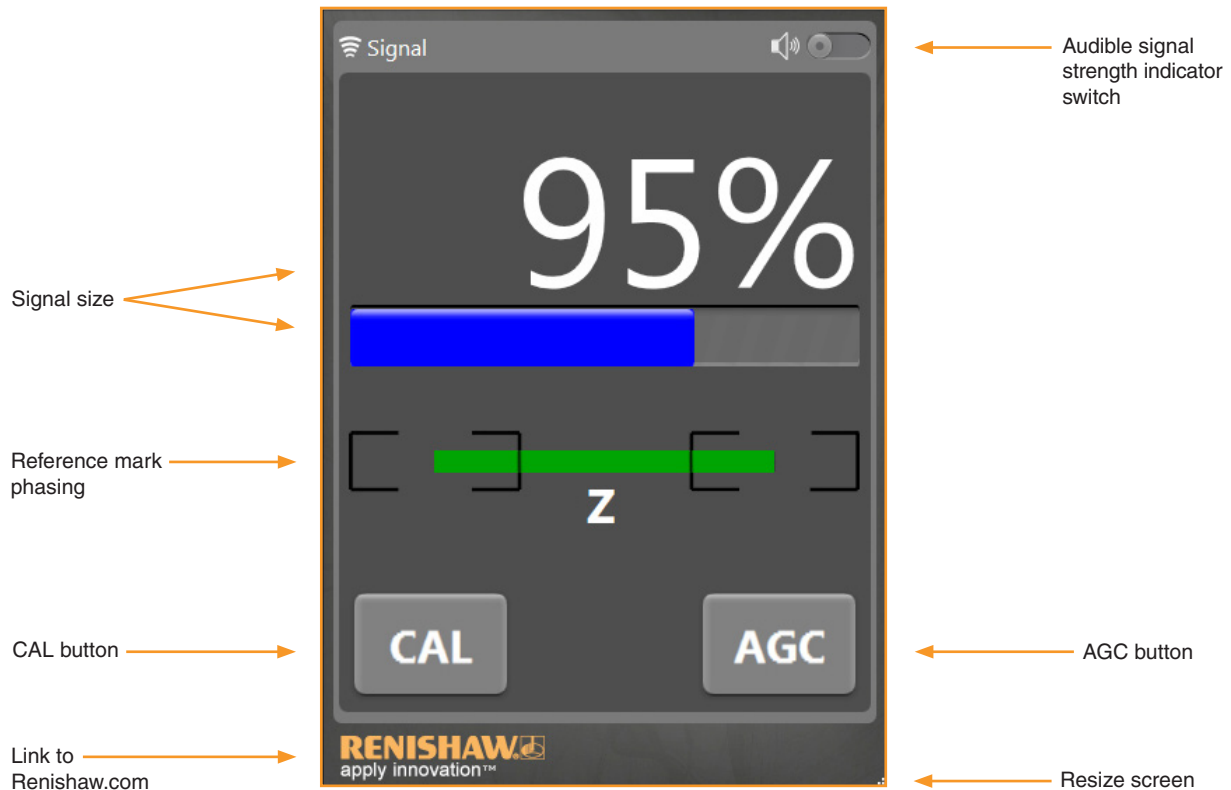

#### 3.3.1. Signal size

The signal size is displayed as a percentage and as a colour bar, the bar changes colour dependant on the signal size.

Signal size	Colour	Indicates
>110%	Purple	Good set-up, no further adjustment required
90% to 110%	Blue	Optimum set-up
70% to 90%	Green	Good set-up, no further adjustment required
50% to 70%	Orange	Acceptable set-up but below the recommended level
<50%	Red	Poor set-up, signal may be too low for reliable operation; adjust set-up

Flashing signal size bar indicates system is in error.

Signal size is also available as an audible indication.

- Click on the sliding switch in the top right hand corner to toggle the audible indication, the switch will be orange when the audible signal is activated. The tone gets higher as the signal level increases.
- Ensure the volume on the PC is switched on.



**NOTE:** When the ATOM dongle is connected the diagnostic LED on the dongle or Ti interface will flash orange, it will not display the signal size. The LED on the readhead will function as normal. See the relevant ATOM installation guide for more information on the readhead LED function.

### 3.3.2. Reference mark phasing

This shows the phasing of the reference mark.

The bar in the centre will move and change colour depending upon the phasing of the reference mark. When the reference mark is correctly phased the bar will flash green as the readhead passes over the chosen reference mark with the start and end of the bar in the boxes at either end.

Example of a correctly phased reference mark:

- Green bar
- Start and end point of bar within the boxes



If the bar flashes orange or red as the readhead passes the chosen reference mark the reference mark is not phased. Refer to the relevant installation manual for details of trouble shooting if the reference mark is not phased.

Examples of poorly phased reference marks:

- Red or orange bar
- Start or end point of bar not within the boxes

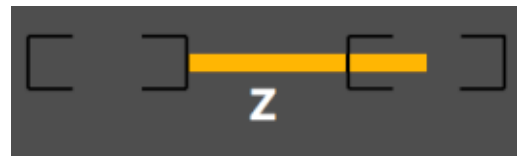
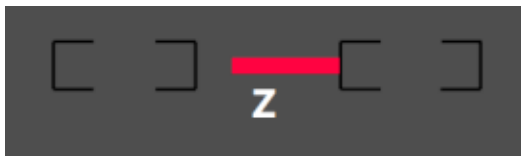

### 3.3.3. CAL button



Before system calibration, ensure AGC is switched off and signal is maximised the along the full axis of travel. Refer to the relevant ATOM installation guide for details of system installation and calibration procedure.

**NOTE:** Signal strength must be  $\geq 70\%$  before calibration can be initiated.

The CAL button will be 'greyed out' if the signal strength is too low for calibration.

#### Calibration routine:

- Click on the CAL button to initiate the calibration procedure.
  - The display will be 'greyed out' and an orange circle with 'Calibration in progress' will be displayed.
  - The CAL button on the software will turn red.  
**NOTE:** The signal strength meter and reference mark phasing indicator will not be active whilst the display is 'greyed out'.
- Move the readhead along the axis, ensuring you do not pass a reference mark.
  - The CAL button on the software will turn orange indicating that the incremental signals are now calibrated and the settings stored in the readhead memory.
- Move the readhead backwards and forwards across the chosen reference mark.
  - The CAL button on the software will turn green indicating the reference mark has been phased.
- The CAL button will turn grey and the signal size and reference mark displays will be reactivated indicating the system has completed its calibration routine and is ready for operation.

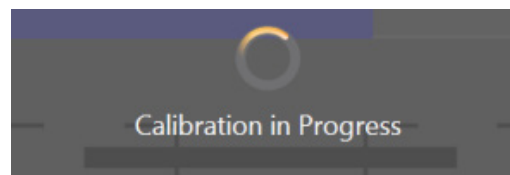

**NOTE:** Refer to the relevant ATOM installation guide for details of the calibration routine.

### 3.3.4. AGC button



Once the system has been calibrated AGC can be enabled/disabled by clicking on this button.

- Click the AGC button.
  - The display will be 'greyed out' and an orange circle with 'Toggling AGC status' will be displayed.
- The display will return to normal and the signal strength meter and reference mark display will be reactivated.
- The AGC status has been toggled.

**NOTE:** The software does not display whether AGC is on or off.  
To see the status of AGC use the LED on the readhead as detailed in the relevant installation guide.

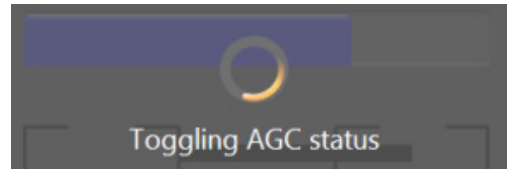

## 4. Faultfinding

### 4.1. Driver installation failure

If, during installation, the software does not find the hardware drivers and 'Device driver software was not successfully installed' is displayed the drivers should be manually installed. See section 5.2, Manual hardware driver installation.

### 4.2. Communication error

If communication is lost with the dongle or attached interface 'Comm Error' warning will flash 10 times.

- The display will be 'greyed out' and display an orange circle with 'Please connect to device' until communication is re-established.

Comm Error



Communication error means that the software cannot talk to the ATOM dongle. Complete the following checks and take remedial actions as required:

- Check the correct interconnect cabling has been used between the readhead and the dongle interface (See section 3.1)
- Check connections between the dongle and the dongle interface and dongle interface and readhead.
- Close software application, unplug USB cable from the dongle, restart the software and reconnect the USB cable. The signal level LED on the interface should start flashing orange and there should be a green LED on the dongle next to the USB connection.
- If the software still does not recognise the ATOM system it may be because the hardware drivers have not been correctly installed. See section 5.2 for details on how to manually install the drivers.  
**NOTE:** Hardware drivers need to be installed for each USB port.
- If the software becomes corrupt see section 6 for details on repairing and uninstalling the software

### 4.3. Calibration failure

If, during the calibration routine, the screen remains 'greyed out' and the CAL button remains red the system is unable to complete calibration as the signal level is too low.

- Click the CAL button to exit the calibration routine.
- The display will show an orange circle with 'Calibration routine aborted'.

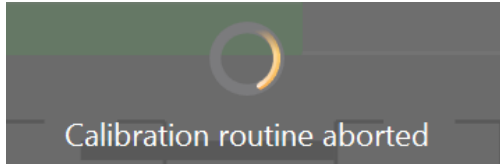

- Restore factory defaults by pressing and holding the CAL button on the dongle interface whilst cycling the power. See the relevant ATOM installation guide for details on restoring factory defaults.
- Check readhead installation and system cleanliness and obtain a green LED on the readhead along the full axis length. See the relevant ATOM installation guide for details on setting up the readhead.
- Repeat the calibration routine.

If, during the calibration routine, the screen remains 'greyed out' and the CAL button remains orange the system is unable to complete calibration as it has not seen the reference mark.

- Ensure the readhead has been moved backwards and forwards over the reference mark several times.
- If the CAL button remains orange, click the CAL button to exit the calibration routine.
- The display will show an orange circle with 'Incremental calibration complete. Now move readhead'.

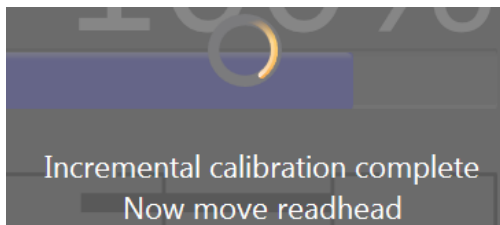

- The incremental calibration settings will be stored in the readhead but the reference mark has not been calibrated.
- Check readhead installation and system cleanliness and obtain a green LED on the readhead along the full axis length. See the relevant ATOM installation guide for details on setting up the readhead.
- Repeat the calibration routine.

## 5. Hardware driver installation

### 5.1. Automatic driver installation

The hardware drivers will automatically be installed when the software is started for the first time.

**DO NOT CONNECT THE SYSTEM TO THE USB PORT BEFORE STARTING THE SOFTWARE FOR THE FIRST TIME AS THE DRIVERS MAY NOT INSTALL CORRECTLY.**

**NOTE:** Hardware drivers need to be installed for each USB port being used for connection to the software.

- Click on the 'ATOM DIAGNOSTIC' icon on the desktop.
- The Device Driver Installation Wizard will start automatically.
- Follow the instructions on the screen and the drivers will automatically be installed for that USB port.

**NOTE:** On Windows 8 it will ask:

'Do you want to allow the following program from an unknown publisher to make changes to this computer?'  
Click **Yes** to continue the driver installation.

- Click **Finish** and the software is ready to use.

### 5.2. Manual hardware driver installation

If the drivers have not automatically installed they can be manually installed.

- Browse C: Program files (x86)/Renishaw/Atom
- Depending upon if it is a 32 bit or 64 bit PC select Drivers (x32) or Drivers (x64).
- Click on DPInst and the Device Driver Installation Wizard will open.
- Follow the instructions on the screen and the drivers will automatically be installed for that USB port.

**NOTE:** On Windows 8 it will ask:

'Do you want to allow the following program from an unknown publisher to make changes to this computer?'  
Click **Yes** to continue the driver installation.

- Click **Finish** and the software is ready to use.

## 6. Repairing/uninstalling the software

- Ensure there are no copies of Renishaw's ATOM software running before attempting to uninstall
- Go to **Control panel >>Programs and Features**.
- Select **ATOM Installer**.
- Select **Uninstall, change** or **repair** as required.
- Follow the instructions on the screen to remove or repair the software as required.

**Renishaw plc**  
New Mills, Wotton-under-Edge,  
Gloucestershire GL12 8JR  
United Kingdom

**T** +44 (0)1453 524524  
**F** +44 (0)1453 524901  
**E** uk@renishaw.com  
[www.renishaw.com](http://www.renishaw.com)

**RENISHAW**   
**apply innovation™**

**For worldwide contact details, please visit our main website at [www.renishaw.com/contact](http://www.renishaw.com/contact)**

RENISHAW HAS MADE CONSIDERABLE EFFORTS TO ENSURE THE CONTENT OF THIS DOCUMENT IS CORRECT AT THE DATE OF PUBLICATION BUT MAKES NO WARRANTIES OR REPRESENTATIONS REGARDING THE CONTENT. RENISHAW EXCLUDES LIABILITY, HOWSOEVER ARISING, FOR ANY INACCURACIES IN THIS DOCUMENT.

**RENISHAW**® and the probe symbol used in the RENISHAW logo are registered trade marks of Renishaw plc in the United Kingdom and other countries.

**apply innovation** and names and designations of other Renishaw products and technologies are trade marks of Renishaw plc or its subsidiaries.

©2014-2015 Renishaw plc All rights reserved Issued 0315



M - 9693 - 9735 - 01