

# TONiC™ diagnostic kit



# Contents

<b>1. General information</b>	<b>1</b>
1.1. Minimum system requirements	1
1.2. General specifications	1
1.3. Legal notices	1
1.4. Dongle kit contents	3
1.5. Dongle dimensions	4
1.6. Dongle interface dimensions	4
1.7. Signals	4
<b>2. Software installation</b>	<b>5</b>
<b>3. Using Renishaw's TONiC diagnostic kit</b>	<b>5</b>
3.1. Connecting the system	6
3.1.1. TONiC with a digital Ti interface (Ti0004 - Ti4000)	6
3.1.2. TONiC with digital Ti interface (Ti10KD or Ti20KD) or analogue Ti interface (Ti0000)	6
3.2. Starting the software	7
3.3. Using the software	8
3.3.1. Signal size	8
3.3.2. Reference mark phasing	9
3.3.3. Pitch indicator	9
3.3.4. Limits	9
3.3.5. CAL button	10
3.3.6. AGC button	10
<b>4. Faultfinding</b>	<b>11</b>
4.1. Driver installation failure	11
4.2. Communication error	11
4.3. Calibration failure	12
4.4. Pitch indicator failure	12
<b>5. Hardware driver installation</b>	<b>13</b>
5.1. Automatic driver installation	13
5.2. Manual hardware driver installation	13
<b>6. Repairing/uninstalling the software</b>	<b>13</b>

## 1. General information

### 1.1. Minimum system requirements

- ▶ Microsoft Windows 8, Windows 7 or Windows XP
- ▶ Microsoft .NET Framework 4.0 Full
- ▶ USB port
- ▶ Internet connection for software download

### 1.2. General specifications

<b>Power supply</b>	5 V ±10%	The dongle can be powered from the USB port or an external 5 V dc supply with the requirements for SELV or standard IEC 60950-1 Dongle current consumption < 50 mA Dongle interface current consumption < 100 mA Ripple < 200mVpp maximum at frequency up to 500 KHz
<b>Temperature</b>	Storage	-20 °C to +70 °C
	Operating	0°C to +70 °C
<b>Humidity</b>		95% relative humidity (non-condensing) to IEC 60068-2-78
<b>Sealing</b>		IP20

### 1.3. Legal notices

#### Copyright

© 2015-2021 Renishaw plc. All rights reserved.

This document may not be copied or reproduced in whole or in part, or transferred to any other media or language by any means, without the prior written permission of Renishaw.

#### Trade marks

RENISHAW® and the probe symbol are registered trade marks of Renishaw plc. Renishaw product names, designations and the mark 'apply innovation' are trade marks of Renishaw plc or its subsidiaries.

Other brand, product or company names are trade marks of their respective owners.

#### Disclaimer

WHILE CONSIDERABLE EFFORT WAS MADE TO VERIFY THE ACCURACY OF THIS DOCUMENT AT PUBLICATION, ALL WARRANTIES, CONDITIONS, REPRESENTATIONS AND LIABILITY, HOWSOEVER ARISING, ARE EXCLUDED TO THE EXTENT PERMITTED BY LAW.

RENISHAW RESERVES THE RIGHT TO MAKE CHANGES TO THIS DOCUMENT AND TO THE EQUIPMENT, AND / OR SOFTWARE AND THE SPECIFICATION DESCRIBED HEREIN WITHOUT OBLIGATION TO PROVIDE NOTICE OF SUCH CHANGES.

#### Terms and conditions and warranty

Unless you and Renishaw have agreed and signed a separate written agreement, the equipment and/or software are sold subject to the Renishaw Standard Terms and Conditions supplied with such equipment and/or software, or available on request from your local Renishaw office.

Renishaw warrants its equipment and software for a limited period (as set out in the Standard Terms and Conditions), provided that they are installed and used exactly as defined in associated Renishaw documentation. You should consult these Standard Terms and Conditions to find out the full details of your warranty.

Equipment and/or software purchased by you from a third-party supplier is subject to separate terms and conditions supplied with such equipment and/or software. You should contact your third-party supplier for details.

#### Product compliance

Renishaw plc declares that TONiC diagnostic kit complies with the applicable standards and regulations.

A copy of the EU declaration of conformity is available from our website at [www.renishaw.com/productcompliance](http://www.renishaw.com/productcompliance).

### Compliance

This device complies with part 15 of the FCC Rules. Operation is subject to the following two conditions:

(1) This device may not cause harmful interference, and (2) this device must accept any interference received, including interference that may cause undesired operation.

The user is cautioned that any changes or modifications not expressly approved by Renishaw plc or authorised representative could void the user's authority to operate the equipment.

This equipment has been tested and found to comply with the limits for a Class A digital device, pursuant to part 15 of the FCC Rules. These limits are designed to provide reasonable protection against harmful interference when the equipment is operated in a commercial environment. This equipment generates, uses, and can radiate radio frequency energy and, if not installed and used in accordance with the instruction manual, may cause harmful interference to radio communications. Operation of this equipment in a residential area is likely to cause harmful interference in which case the user will be required to correct the interference at his own expense.

**NOTE:** This unit was tested with shielded cables on the peripheral devices. Shielded cables must be used with the unit to ensure compliance.

### Further information

Further information relating to the TONiC encoder range can be found in the TONiC system Data sheet and Installation guides. These can be downloaded from our website [www.renishaw.com/tonicdownloads](http://www.renishaw.com/tonicdownloads) and are also available from your local Renishaw representative.

### Packaging

Packaging Component	Material	ISO 11469	Recycling Guidance
Outer box	Cardboard	Not applicable	Recyclable
	Polypropylene	PP	Recyclable
Inserts	Low density polyethylene foam	LDPE	Recyclable
	Cardboard	Not applicable	Recyclable
Bags	High density polyethylene bag	HDPE	Recyclable
	Metalised polyethylene	PE	Recyclable

### REACH regulation

Information required by Article 33(1) of Regulation (EC) No. 1907/2006 ("REACH") relating to products containing substances of very high concern (SVHCs) is available at [www.renishaw.com/REACH](http://www.renishaw.com/REACH).

### WEEE recycling guidelines



The use of this symbol on Renishaw products and/or accompanying documentation indicates that the product should not be mixed with general household waste upon disposal. It is the responsibility of the end user to dispose of this product at a designated collection point for waste electrical and electronic equipment (WEEE) to enable reuse or recycling. Correct disposal of this product will help to save valuable resources and prevent potential negative effects on the environment. For more information, please contact your local waste disposal service or Renishaw distributor.

### 1.4. Dongle kit contents

▶ A-9411-0011:

Item	Description	Quantity
1	Dongle	1
2	Dongle interface	1
3	USB cable	1
4	Interface cable for ATOM™ 15-way D-type readheads	1
5	Interface cable for TONiC and ATOM readheads	1
6	Sacrificial interconnect PCB for TONiC and ATOM cabled readheads	10
7	Sacrificial interconnect PCB for ATOM FPC readheads	10

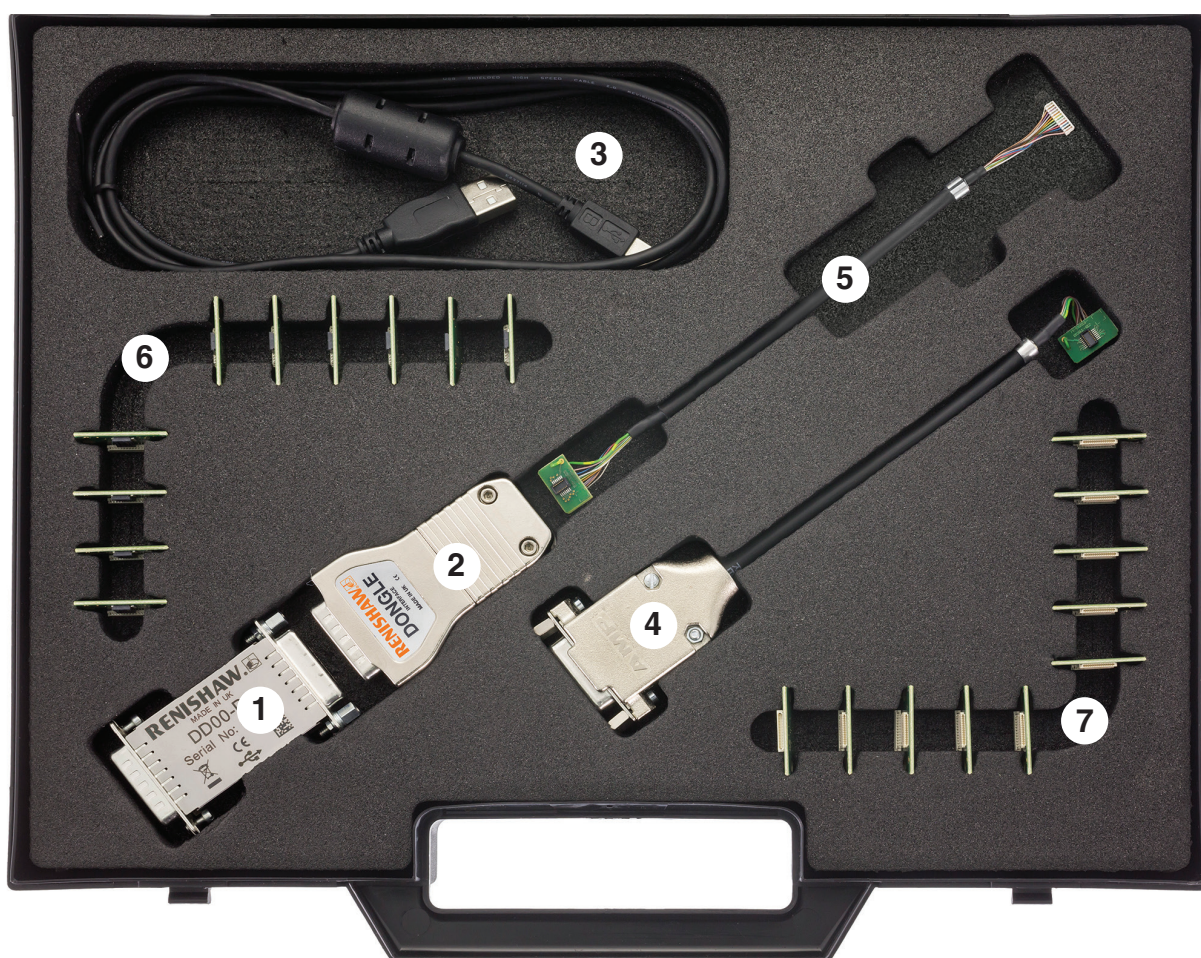

The dongle interface/Ti interface connector is not designed for multiple insertions and removals. The sacrificial interconnect PCB's should be used and replaced when worn or damaged.

Packs of 10 replacement PCB's are available to order:

- ▶ Item 6: A-9411-0016
- ▶ Item 7: A-9411-0017

### 1.5. Dongle dimensions

Dimensions and tolerances in mm

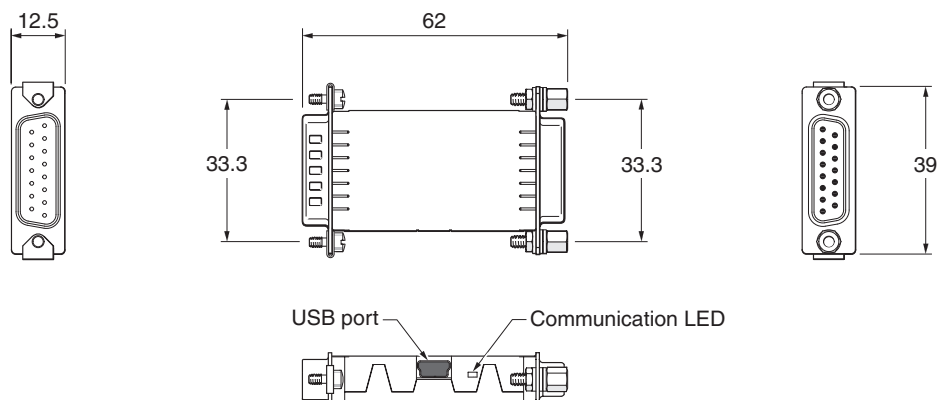

### 1.6. Dongle interface dimensions

Dimensions and tolerances in mm

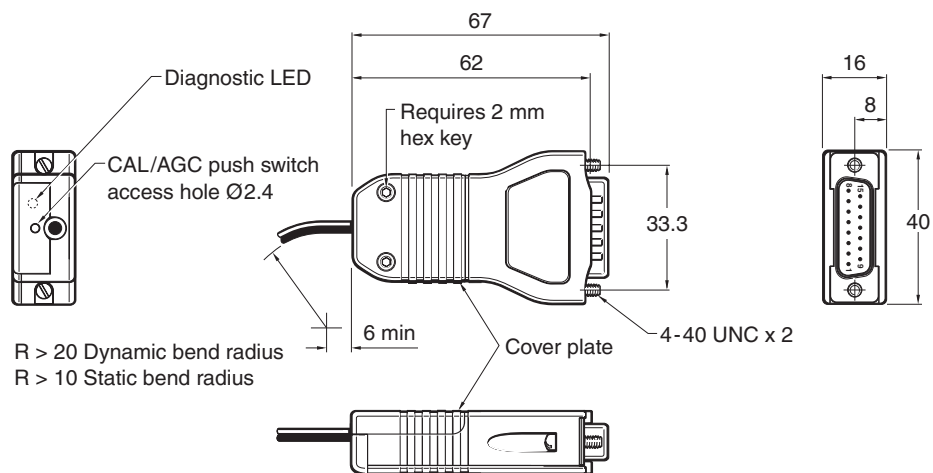

### 1.7. Signals

Function	Signal	Dongle interface	Dongle		
		Output pin (male 15-way D-type)	Input pin (female 15-way D-type)	Ouput pin (male 15-way D-type)	
Power	5 V	7, 8	7, 8	7, 8	
	0 V	2, 9	2, 9	2, 9	
Incremental	A	+	14	14	14
		-	6	6	6
	B	+	13	13	13
		-	5	5	5
Reference mark	Z	+	12	12	12
		-	4	4	4
Limits	P	11	11	11	
	Q	10	10	10	
Alarm	E	+	11	11	11
		-	3	3	3
External set-up	X	1	1	-	
Shield	Inner screen	15	15	15	

## 2. Software installation

**Full administration rights are necessary to install and uninstall the TONiC hardware drivers and software.**

Before installing a new version of the TONiC software ensure that any previous versions have been uninstalled ('6. Repairing/uninstalling the software', page 13).

- ▶ Download the TONiC diagnostic software installation file from the TONiC downloads page on [www.renishaw.com/tonicdownloads](http://www.renishaw.com/tonicdownloads)
- ▶ It will ask 'Do you want to run or save TONiC installer.exe from renishaw.com?'
- ▶ Click **Run**.
- ▶ The InstallShield Wizard will start automatically.
- ▶ Follow the instructions on the screen and the installation program will automatically run through the installation process.

**NOTE:** On Windows 8 it will ask :

'Do you want to allow the following program from an unknown publisher to make changes to this computer ?'  
Click **Yes** to continue the installation.

- ▶ Once the software installation has completed click **Finish** to close the window.
- ▶ The software will have installed an icon on the desktop.



## 3. Using Renishaw's TONiC diagnostic kit

The TONiC diagnostic kit can be used to connect the TONiC system, via a USB link, to a PC to assist with the set-up. The software displays:

- ▶ Signal size
- ▶ Reference mark phasing
- ▶ Limits
- ▶ Readhead pitch

It also allows system calibration to be initiated and Automatic Gain Control (AGC) to be toggled. The dongle can be powered via the USB connection or in-line with the customers' electronics.

### 3.1. Connecting the system

Choose the appropriate interconnect cabling for your system from the options below and connect the TONiC readhead to the dongle.

Readhead	Interface	Section
TONiC	Ti0004 - Ti4000	3.1.1.
TONiC	Ti0000 Ti10KD Ti20KD	3.1.2.

#### 3.1.1. TONiC with a digital Ti interface (Ti0004 - Ti4000)

- ▶ Items required for connection:
  - Item 1, dongle
  - Item 3, USB cable
- ▶ Connect the TONiC readhead to the Ti interface. See the relevant TONiC installation guide for details of connecting the readhead to the Ti interface (System connection).
- ▶ Connect the output of the Ti interface to the input of the dongle
- ▶ If using the diagnostic dongle 'in-line' connect the output of the dongle to the customers' controller
- ▶ Proceed to section 3.2. ('3.2. Starting the software', page 7)



#### 3.1.2. TONiC with digital Ti interface (Ti10KD or Ti20KD) or analogue Ti interface (Ti0000)

**NOTE:** Ti0000, Ti10KD and Ti20KD are not compatible with the diagnostic dongle so the system should be connected using the dongle interface

- ▶ Items required for connection:
  - Item 6, sacrificial interconnect PCB for TONiC or ATOM cabled readheads.
  - Item 5, Interface cable for TONiC or ATOM readheads.
  - Item 2, dongle interface.
  - Item 1, dongle.
  - Item 3, USB cable.

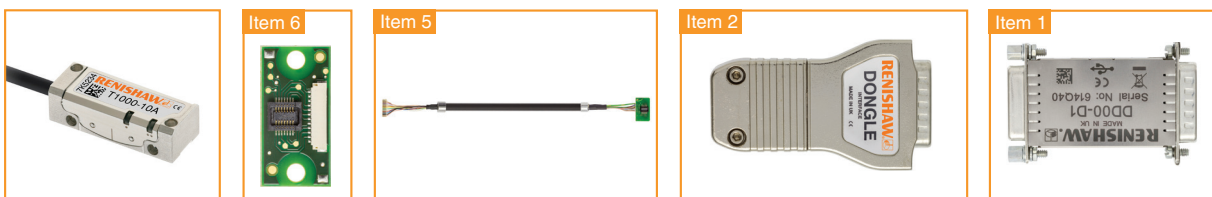

- ▶ Do not connect the readhead to the interface.
- ▶ Connect the sacrificial interconnect PCB to the JST connector on the interface cable (Item 5).
- ▶ Connect the mini PCB on the cabled TONiC readhead to the sacrificial interconnect PCB for cabled readheads (Item 6). Ensure correct orientation of the connector, both cables will come out of the same side of the pcb.
- ▶ Open the cover plate on the dongle interface (Item 2) and connect the mini PCB into the interface. See the relevant TONiC installation guide for details of connecting the readhead to the dongle interface (System connection).
- ▶ Connect the output of the dongle interface to the input of the dongle (Item 1).
- ▶ Proceed to section 3.2 ('3.2. Starting the software', page 7)

**NOTE:** The dongle interface/Ti interface connector is not designed for multiple insertions and removals. The sacrificial interconnect PCB's should be used and replaced when worn or damaged.



### 3.2. Starting the software

ON FIRST USE DO NOT CONNECT THE SYSTEM TO THE USB PORT BEFORE STARTING THE SOFTWARE.

On first use the software will automatically install the hardware drivers ('5. Hardware driver installation', page 13).

- ▶ Double click on the 'TONiC diagnostic' icon on the desktop.
- ▶ The software will open a 'greyed out' window displaying the 'Start page' with an orange circle saying 'Please connect to device' indicating that it is waiting for the TONiC system to be connected.
- ▶ Using the USB cable (item 3) connect the dongle via the USB port to the PC.  
See '3.1. Connecting the system', page 6 for details on connecting the TONiC readhead to the dongle.

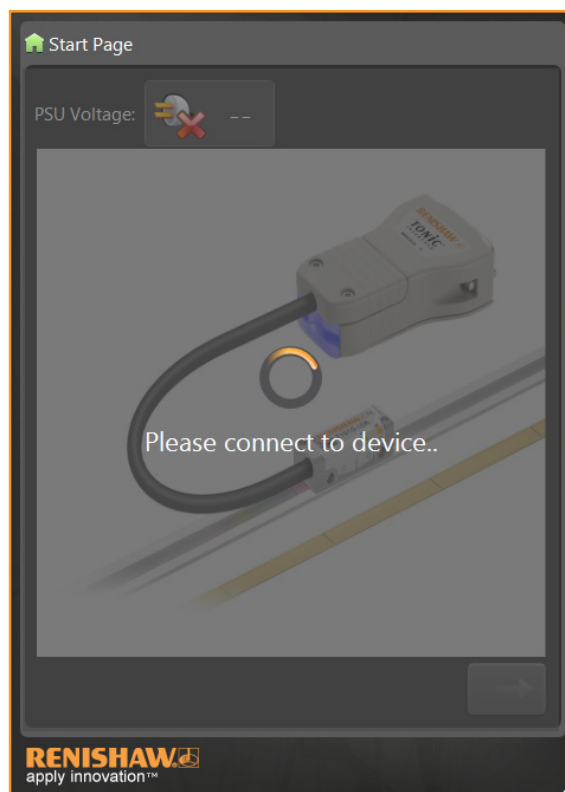

- ▶ The 'Start page' will then become active.
  - The PSU voltage will display USB showing it is powered via the USB port or the supply voltage if used 'in-line'.
  - The diagnostic LED on the dongle interface or Ti interface will now double flash orange and the communication LED on the dongle will be green. The CAL LED on the readhead will double flash orange.
- ▶ Click on the green arrow to enter the software.
  - The 'Signal' screen will now be displayed ('3.3. Using the software', page 8).
  - The diagnostic LED on the dongle interface or Ti interface will continue double flashing orange and the communication LED on the dongle will be green. The CAL LED on the readhead will stop flashing.

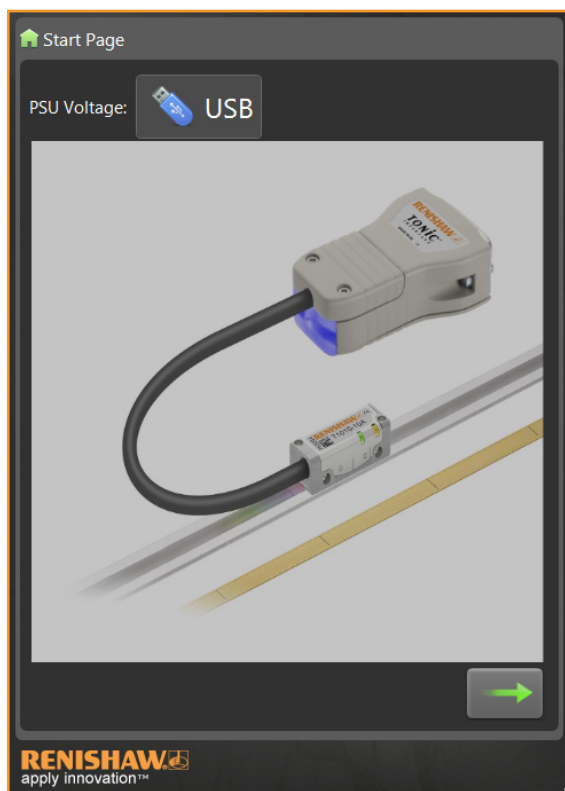

### 3.3. Using the software

This section explains the functions of software. It should be used in conjunction with the relevant TONiC installation guide for details on how to install and set the system up. Only one copy of the software should be opened at a time with only a single TONiC system connected to it.

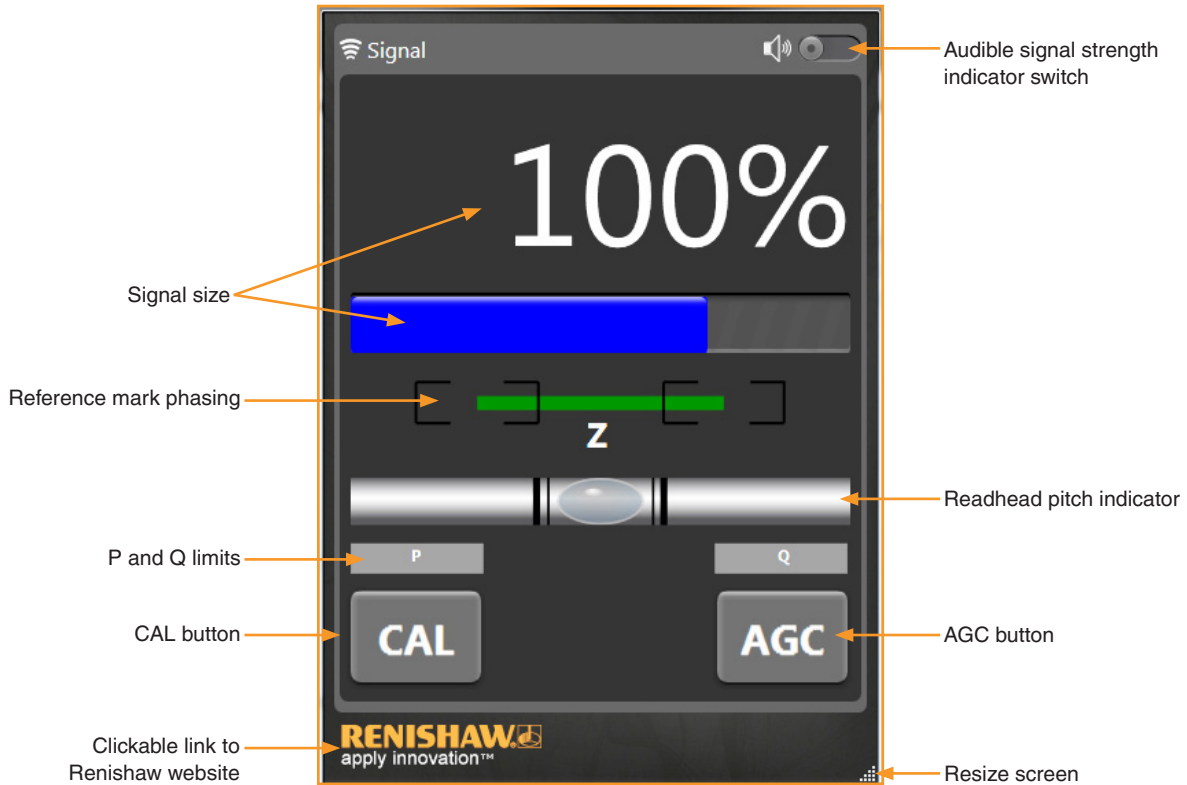

#### 3.3.1. Signal size

The signal size is displayed as a percentage and as a colour bar, the bar changes colour dependant on the signal size.

Signal size	Colour	Indicates
> 110%	Purple	Good set-up, no further adjustment required
90% to 110%	Blue	Optimum set-up
70% to 90%	Green	Good set-up, no further adjustment required
50% to 70%	Orange	Acceptable set-up but below the recommended level
< 50%	Red	Poor set-up, signal may be too low for reliable operation; adjust set-up

Flashing signal size bar indicates system is in error.

Signal size is also available as an audible indication.

- ▶ Ensure the volume on the PC is switched on.
- ▶ Click on the sliding switch in the top right hand corner to toggle the audible indication, the switch will be orange when the audible signal is activated. The tone gets higher as the signal level increases.

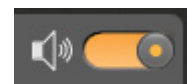

**NOTE:** When the TONiC dongle is connected the diagnostic LED on the dongle interface or Ti interface will flash orange, it will not display the signal size. The set-up LED on the readhead will function as normal. See the relevant TONiC installation guide for more information on the readhead LED function.

### 3.3.2. Reference mark phasing

This shows the phasing of the reference mark.

The bar in the centre will move and change colour depending upon the phasing of the reference mark. When the reference mark is correctly phased the bar will flash green as the readhead passes over the chosen reference mark with the start and end of the bar in the boxes at either end.

Example of a correctly phased reference mark:

- ▶ Green bar
- ▶ Start and end point of bar within the boxes



If the bar flashes orange or red as the readhead passes the chosen reference mark the reference mark is not phased. Refer to the relevant installation manual for details of troubleshooting if the reference mark is not phased.

Examples of poorly phased reference marks:

- ▶ Red or orange bar
- ▶ Start or end point of bar not within the boxes

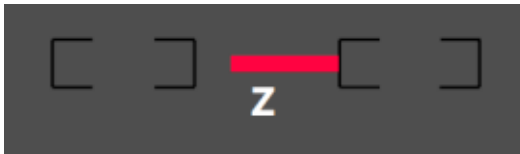

### 3.3.3. Pitch indicator



The pitch of the readhead is displayed as a spirit level. To ensure the correct pitch the 'bubble' should be positioned between the two thick black lines. The 'bubble' will move briefly to either end of the bar as it passes over a reference mark.

**NOTE:** When setting the pitch of the readhead ensure the readhead is not near a reference mark.

**NOTE:** If switching power on/off via the USB to restore factory defaults the power must be cycled again (i.e. USB unplugged and reconnected) for the software to function correctly. If the power is not cycled the pitch indicator will not function. See the relevant TONiC installation guide for details on restoring factory defaults.

### 3.3.4. Limits



When the readhead is moved over a limit the corresponding limit will turn green.

**NOTE:** If using a digital Ti interface (Ti0004 - Ti4000) option E, F, G or H the P limit will turn green when the alarm is initiated as the P output is used for the alarm (E+) output.

### 3.3.5. CAL button



Before system calibration, ensure AGC is switched off and signal is maximised the along the full axis of travel. Refer to the relevant TONiC installation guide for details of system installation and calibration procedure.

**NOTE:** Signal strength must be  $\geq 70\%$  before calibration can be initiated. The CAL button will be 'greyed out' if the signal strength is too low for calibration.

#### Calibration routine:

- ▶ Click on the CAL button to initiate the calibration procedure.
  - The display will be 'greyed out' and a box showing a moving readhead above some scale and an arrow will be displayed for 10 seconds. The CAL LED on the readhead will periodically single-flash.

**NOTE:** The signal strength meter and reference mark phasing indicator will not be active whilst the display is 'greyed out'.

- ▶ Move the readhead along the axis, ensuring you do not pass a reference mark. The CAL LED on the readhead starts double-flashing.
- ▶ Move the readhead backwards and forwards across the chosen reference mark.
- ▶ The CAL button will turn grey and the signal size and reference mark displays will be reactivated indicating the system has completed its calibration routine and is ready for operation. The CAL LED on the readhead will stop flashing.

**NOTE:** Clicking on the CAL button initiates the CAL routine and indicates the action required. It does not indicate that calibration is complete or has been successful. Refer to the relevant TONiC installation guide for details of the calibration routine.

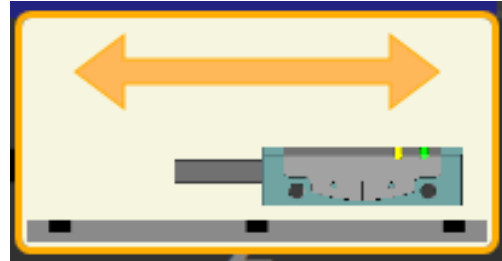

### 3.3.6. AGC button



Once the system has been calibrated AGC can be enabled/disabled by clicking on this button.

- ▶ Click the AGC button.
  - The display will be 'greyed out' and an orange circle with 'Toggling AGC status' will be displayed.

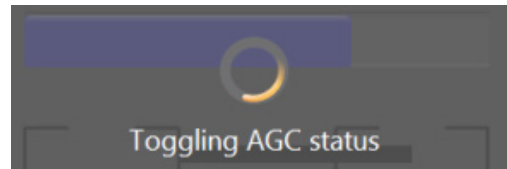

- ▶ The display will return to normal and the signal strength meter and reference mark display will be reactivated.
- ▶ The AGC status has been toggled.

**NOTE:** The software does not display whether AGC is on or off. To see the status of AGC use the CAL LED on the readhead as detailed in the relevant installation guide.

## 4. Faultfinding

### 4.1. Driver installation failure

If, during installation, the software does not find the hardware drivers, 'Device driver software was not successfully installed', the drivers should be manually installed ('5.2. Manual hardware driver installation', page 13).

### 4.2. Communication error

If communication is lost with the dongle or attached interface 'Comm Error' warning will flash 10 times.

- ▶ The display will be 'greyed out' and display an orange circle with 'Please connect to device' until communication is re-established.

Comm Error



Communication error means that the software cannot talk to the TONiC dongle.

Complete the following checks and take remedial actions as required:

- ▶ Check the correct interconnect cabling has been used between the readhead and the dongle interface ('3.1. Connecting the system', page 6). The dongle must be used with the dongle interface unless using a Ti0004 - Ti4000.
- ▶ Check connections between the dongle and the dongle interface and dongle interface and readhead.
- ▶ Close software application, unplug USB cable from the dongle, restart the software and reconnect the USB cable. The signal level LED on the dongle interface/Ti interface should start flashing orange and there should be a green LED on the dongle next to the USB connection.
- ▶ If the software still does not recognise the TONiC system it may be because the hardware drivers have not been correctly installed. See '5.2. Manual hardware driver installation', page 13 for details on how to manually install the drivers.  
**NOTE:** Hardware drivers need to be installed for each USB port.
- ▶ If the software becomes corrupt see '6. Repairing/uninstalling the software', page 13 for details on repairing and uninstalling the software

### **4.3. Calibration failure**

The software does not display if the calibration routine has failed. To check calibration status use the CAL LED on the TONiC readhead. If calibration fails restore factory defaults by pressing and holding the CAL button on the dongle interface whilst cycling the power. See the relevant TONiC installation guide for details of the calibration routine and restoring factory defaults.

### **4.4. Pitch indicator failure**

Ensure the readhead is not over a reference mark when checking the readhead pitch. If the pitch indicator 'bubble' does not move on pitching the head or remains to one side of the centre unplug and reconnect the USB to cycle the power.

## 5. Hardware driver installation

### 5.1. Automatic driver installation

The hardware drivers will automatically be installed when the software is started for the first time.

**DO NOT CONNECT THE SYSTEM TO THE USB PORT BEFORE STARTING THE SOFTWARE FOR THE FIRST TIME AS THE DRIVERS MAY NOT INSTALL CORRECTLY.**

**NOTE:** Hardware drivers need to be installed for each USB port being used for connection to the software.

- ▶ Click on the '**TONiC diagnostic**' icon on the desktop.
- ▶ The Device Driver Installation Wizard will start automatically.
- ▶ Follow the instructions on the screen and the drivers will automatically be installed for that USB port.

**NOTE:** On Windows 8 it will ask:

'Do you want to allow the following program from an unknown publisher to make changes to this computer?'

Click **Yes** to continue the driver installation.

- ▶ Click **Finish** and the software is ready to use.

### 5.2. Manual hardware driver installation

If the drivers have not automatically installed they can be manually installed.

- ▶ Browse C: Program files (x86)/Renishaw/TONiC diagnostic.
- ▶ Depending upon if it is a 32 bit or 64 bit PC select Drivers (x32) or Drivers (x64).
- ▶ Click on DPInst and the Device Driver Installation Wizard will open.
- ▶ Follow the instructions on the screen and the drivers will automatically be installed for that USB port.

**NOTE:** On Windows 8 it will ask:

'Do you want to allow the following program from an unknown publisher to make changes to this computer?'

Click **Yes** to continue the driver installation.

- ▶ Click **Finish** and the software is ready to use.

## 6. Repairing/uninstalling the software

- ▶ Ensure there are no copies of Renishaw's TONiC software running before attempting to uninstall.
- ▶ Go to **Control panel >>Programs and Features**.
- ▶ Select **TONiC diagnostic**.
- ▶ Select **uninstall, change** or **repair** as required.
- ▶ The InstallShield Wizard software will start automatically.
- ▶ Follow the instructions on the screen to remove or repair the software as required.

**Renishaw plc**  
New Mills, Wotton-under-Edge,  
Gloucestershire, GL12 8JR,  
United Kingdom

**T** +44 (0)1453 524524  
**F** +44 (0)1453 524901  
**E** uk@renishaw.com  
[www.renishaw.com](http://www.renishaw.com)

**RENISHAW**   
**apply innovation™**

For worldwide contact details, visit [www.renishaw.com/contact](http://www.renishaw.com/contact)

Renishaw plc. Registered in England and Wales. Company no: 1106260.  
Registered office: New Mills, Wotton-under-Edge, Gloucestershire, GL12 8JR, UK.



M - 9589 - 9081 - 02

Part no.: M-9589-9081-02-A  
Issued: 02.2021