

RESOLUTE™ absolute optical encoder system



- True-absolute non-contact optical encoder system: no batteries required
- Wide set-up tolerances for quick and easy installation
- High immunity to dirt, scratches and light oils
- Resolutions to 1 nm linear or 32 bit rotary
- 100 m/s maximum speed for all resolutions (up to 36 000 rev/min)
- ± 40 nm sub-divisional error for smooth velocity control
- Less than 10 nm RMS jitter for improved positional stability
- Built-in separate position-checking algorithm provides inherent safety
- IP64 sealed readhead for high reliability in harsh environments
- Integral set-up LED enables easy installation and provides diagnostics at a glance
- Operates up to 80 °C
- Integral over-temperature alarm
- Compatible with a wide range of linear, rotary, and partial arc scales

RESOLUTE™ is a true-absolute fine-pitch optical encoder system with excellent metrology performance.

Patented RESOLUTE encoder technology combines 1 nm resolution with exceptionally high speed, reading from a range of high-accuracy linear tape and spar scales or angle encoder rings.

RESOLUTE encoder systems use a single optical absolute track with a nominal pitch of 30 μm , combined with sophisticated optics. This ensures wide set-up tolerances, very low sub-divisional error and ultra-low noise (jitter), resulting in better velocity control performance and rock solid positional stability.

The RESOLUTE system ensures reliability with excellent dirt immunity, built-in separate position-checking algorithm and IP64 sealed readhead with wipe-clean recovery.

RESOLUTE encoders are available with BiSS-C (unidirectional), FANUC, Mitsubishi, Panasonic, Siemens DRIVE-CLiQ and Yaskawa serial interfaces.

System features

Unique single-track absolute optical scale

- Absolute position is determined immediately upon switch-on
- No battery back-up
- No yaw de-phasing unlike multiple-track systems
- Fine pitch (30 µm nominal period) optical scale for superior motion control compared to inductive, magnetic or other non-contact optical absolute encoders
- High-accuracy graduations marked directly onto tough engineering materials for outstanding metrology and reliability

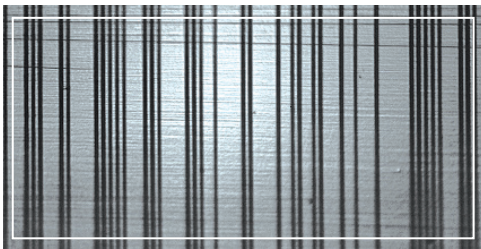

High dirt immunity

- Advanced optics and embedded surplus code means the RESOLUTE encoder system even reads dirty scale
- Absolute position can be determined in all three cases shown here; clean scale (left), grease contamination (below-left), particle contamination (below)

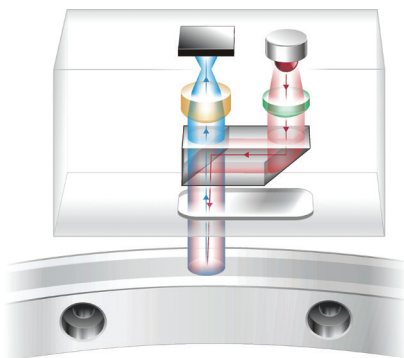
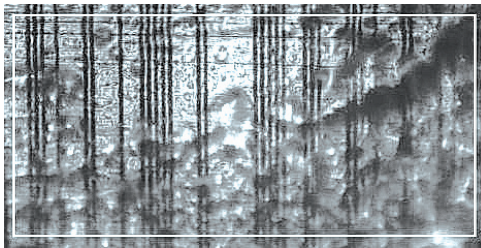

Unique detection method

- Readhead acts like an ultra-fast miniature digital camera, taking photos of a coded scale
- Photos are analysed by a high-speed digital signal processor (DSP) to determine absolute position
- Built-in position-check algorithm constantly monitors calculations for ultimate safety and reliability
- Advanced optics and position determination algorithms are designed to provide low noise (jitter < 10 nm RMS) and low sub-divisional error (SDE ±40 nm)

Optional Advanced Diagnostic Tool

The RESOLUTE encoder system is compatible with the Advanced Diagnostic Tool ADTa-100¹ and ADT View software, which acquire detailed real-time data from the readhead to allow easy set-up, optimisation and in-field fault finding.

The intuitive software interface provides:

- Digital readout of encoder position and signal strength
- Graph of signal strength over the entire axis travel
- Ability to set a new zero position for the encoder system
- System configuration information

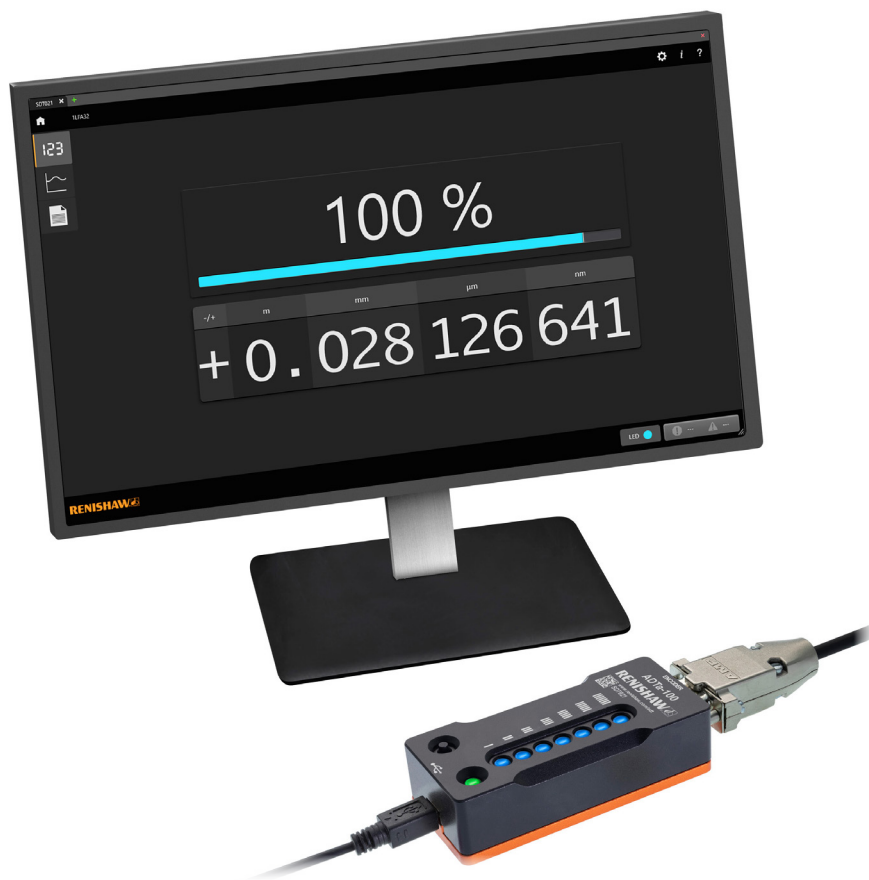

¹ ADTa-100 compatible readheads are marked with the symbol **ADT**

RESOLUTE serial interfaces

RESOLUTE readheads are available in a range of serial interfaces:

Linear readheads

Serial interfaces	Readhead type			
	Standard	Ultra-high vacuum (UHV) ¹	Extended temperature range (ETR) ¹	Functional safety (FS) ¹
BiSS-C (unidirectional)	✓	✓	✓	-
BiSS Safety	-	-	-	✓
FANUC	✓	-	-	-
Mitsubishi	✓	-	-	-
Panasonic	✓	✓	-	-
Siemens DRIVE-CLiQ	✓	-	-	✓
Yaskawa	✓	-	-	-

Rotary readheads



Serial interfaces	Readhead type		
	Standard	Ultra-high vacuum (UHV) ¹	Functional safety (FS) ¹
BiSS C (unidirectional)	✓	✓	-
BiSS Safety	-	-	✓
FANUC	✓	-	-
Mitsubishi	✓	-	-
Panasonic	✓	✓	-
Siemens DRIVE-CLiQ	✓	-	✓
Yaskawa	✓	-	-

Partial arc readheads



Serial interfaces	Readhead type
	Standard
BiSS C (unidirectional)	✓
FANUC	✓
Mitsubishi	✓
Panasonic	✓
Siemens DRIVE-CLiQ	✓
Yaskawa	✓

¹ Separate data sheets are available for ETR, UHV and Functional Safety RESOLUTE readheads at www.renishaw.com/resolutedownloads.

Compatible linear scales

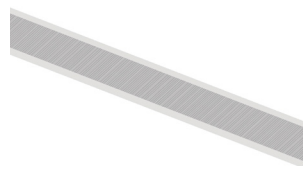
	RTLA30-S¹ Self-adhesive mounted stainless steel tape scale	RTLA30 (with <i>FASTRACK</i>™ carrier) Stainless steel tape scale and self-adhesive mounted carrier
		
Form (height x width)	0.4 mm x 8 mm including adhesive	RTLA30 scale: 0.2 mm x 8 mm <i>FASTRACK</i> carrier: 0.4 mm x 18 mm including adhesive
Accuracy (at 20 °C)	±5 µm/m	±5 µm/m
Maximum length²	21 m	RTLA30 lengths up to 21 m <i>FASTRACK</i> carrier lengths up to 25 m
Coefficient of thermal expansion (at 20 °C)	10.1 ±0.2 µm/m/°C	10.1 ±0.2 µm/m/°C

	RKLA30-S Self-adhesive mounted stainless steel tape scale
	
Form (height x width)	0.15 mm x 6 mm including adhesive
Accuracy (at 20 °C)	±5 µm/m
Maximum length²	21 m
Coefficient of thermal expansion (at 20 °C)	Matches that of substrate material when scale ends fixed by epoxy mounted end clamps



	RELA30 Self-adhesive or clip/clamp mounted low-expansion ZeroMet™ spar scale	RSLA30 Self-adhesive or clip/clamp mounted stainless steel spar scale
		
Form (height x width)	1.5 mm x 14.9 mm	1.6 mm x 14.9 mm
Accuracy (at 20 °C)	Up to 1 m : ±1 µm 1 m to 1.5 m : ±1 µm/m	Up to 1 m : ±1.5 µm 1 m to 2 m : ±2.25 µm 2 m to 3 m : ±3 µm 3 m to 5 m : ±4 µm
Maximum length²	1.5 m	5 m
Coefficient of thermal expansion (at 20 °C)	0.75 ±0.35 µm/m/°C	10.1 ±0.2 µm/m/°C

¹ For RTLA30-S axis lengths > 2 m, the *FASTRACK* carrier with RTLA30 is recommended.

² The maximum scale length may be limited for some serial interfaces and resolutions; refer to 'Resolution and scale lengths' on page 7 for details.

For more information about the linear scales refer to the relevant absolute scale data sheet which can be downloaded from www.renishaw.com/resolutedownloads.

Compatible rotary scales

	RESA30	REXA30
	303/304 stainless steel ring	Ultra-high accuracy 303/304 stainless steel ring
		
Accuracy (at 20 °C)	±1.9 arc second (Typical installed accuracy for a 550 mm diameter ring) ¹	±1 arc second ² (Total installed accuracy for ring diameters ≥ 100 mm)
Ring diameters	52 mm to 550 mm	52 mm to 417 mm
Coefficient of thermal expansion (at 20 °C)	15.5 ±0.5 µm/m/°C	15.5 ±0.5 µm/m/°C

Compatible partial arc scales

	RKLA30-S
	Self-adhesive mounted stainless steel tape scale
	
Form (height x width)	0.15 mm x 6 mm including adhesive
Accuracy (at 20 °C)	±5 µm/m
Maximum length ³	21 m
Coefficient of thermal expansion (at 20 °C)	10.1 ±0.2 µm/m/°C
Minimum arc radius ⁴	50 mm

¹ 'Typical' installations are a result of graduation and installation errors combining and, to some magnitude, cancelling.

² Accuracy when using two RESOLUTE readheads. For the accuracy value of ring diameters < 100 mm, see *REXA30 ultra-high accuracy absolute angle encoder* data sheet (Renishaw part no. L-9517-9405).

³ The maximum scale length may be limited for some serial interfaces and resolutions; refer to 'Resolution and scale lengths' on page 7 for details.

⁴ For smaller radii, contact your local Renishaw representative.

For more information about the rotary scales refer to the relevant absolute scale data sheet which can be downloaded from www.renishaw.com/resolutedownloads.

Linear/partial arc encoder system

Resolution and scale lengths

The maximum scale length depends upon the serial interface, readhead resolution and the number of position bits.

The table below shows the maximum scale length for each system:

Serial interfaces	Position bits	Resolution			
		1 nm	5 nm	50 nm	100 nm
BiSS-C (unidirectional)	26 bit	67 mm	336 mm	3.355 m	-
	32 bit	4.295 m	21 m	21 m	-
	36 bit	21 m	21 m	21 m	-
FANUC	37 bit	21 m	-	21 m	-
Mitsubishi	40 bit	2.1 m	-	21 m	-
Panasonic	48 bit	21 m	-	21 m	21 m
Siemens DRIVE-CLiQ	28 bit	-	-	13.42 m	-
	34 bit	17.18 m	-	-	-
Yaskawa	36 bit	1.8 m	-	21 m	-

Speed

The table below shows the maximum speed for each system:

Serial interfaces	Position bits	Resolution			
		1 nm	5 nm	50 nm	100 nm
BiSS-C (unidirectional)	26 bit	100 m/s	100 m/s	100 m/s	-
	32 bit	100 m/s	100 m/s	100 m/s	-
	36 bit	100 m/s	100 m/s	100 m/s	-
FANUC	37 bit	100 m/s	-	100 m/s	-
Mitsubishi	40 bit	100 m/s	-	100 m/s	-
Panasonic	48 bit (when used with A5 series)	0.4 m/s	-	20 m/s	40 m/s
	48 bit (when used with A6 series)	4 m/s	-	100 m/s	100 m/s
Siemens DRIVE-CLiQ	28 bit	-	-	100 m/s	-
	34 bit	100 m/s	-	-	-
Yaskawa	36 bit	3.6 m/s	-	100 m/s	-

Angle encoder system

Resolution

RESOLUTE angle encoders are available with a variety of resolutions, dependent upon the serial interface being used.

All ring sizes are available for all serial interfaces and resolutions

Serial interfaces		Resolution	Counts per revolution	Arc second
BiSS-C (unidirectional)		18 bit	262 144	≈ 4.94
		26 bit	67 108 864	≈ 0.019
		32 bit	4 294 967 296	≈ 0.0003
FANUC		27 bit	134 217 728	≈ 0.0097
		31 bit	2 147 483 648	≈ 0.0006
Mitsubishi		23 bit	8 388 608	≈ 0.15
		27 bit	134 217 728	≈ 0.0097
Panasonic		23 bit	8 388 608	≈ 0.15
		32 bit	4 294 967 296	≈ 0.0003
Siemens DRIVE-CLiQ		26 bit	67 108 864	≈ 0.019
		29 bit	536 870 912	≈ 0.0024
Yaskawa	Rotary servomotors	24 bit	16 777 216	≈ 0.077
		23 bit	8 388 608	≈ 0.15
	Full closed loop control	26 bit	67 108 864	≈ 0.019
		30 bit	1 073 741 824	≈ 0.0012

NOTE: 32 bit resolution is below the noise floor of the RESOLUTE encoder.

Angle absolute encoder

Speed and accuracy

The table below shows the maximum speed and typical installed accuracy for RESOLUTE readheads with standard diameter RESA30 rings.

RESA30 diameter (mm)	Maximum reading speed (rev/min)						Typical installed accuracy ¹ (arc second)
	BiSS, FANUC, Mitsubishi, Siemens DRIVE-CLiQ	Panasonic	Yaskawa				
			23 bit	24 bit	26 bit	30 bit	
52	36 000	7 200 ²	14 600	14 600	3 250	203	±12.7
57	33 000	7 200 ²	14 600	14 600	3 250	203	±11.8
75	25 000	7 200 ²	14 600	14 600	3 250	203	±9.5
100	19 000	7 200 ²	14 600	14 600	3 250	203	±7.5
101	19 000	7 200 ²	14 600	14 600	3 250	203	±7.5
103	18 500	7 200 ²	14 600	14 600	3 250	203	±7.4
104	18 000	7 200 ²	14 600	14 600	3 250	203	±7.3
115	16 500	6 600	14 600	14 600	3 250	203	±6.8
124	15 000	6 100	14 600	14 600	3 250	203	±6.3
150	12 000	5 000	12 000	12 000	3 250	203	±5.5
165	11 500	4 600	11 500	11 500	3 250	203	±7.0
172	11 000	4 400	11 000	11 000	3 250	203	±5.0
183	10 400	4 200	10 400	10 400	3 250	203	±4.7
200	9 500	3 800	9 500	9 500	3 250	203	±4.3
206	9 200	3 700	9 200	9 200	3 250	203	±4.2
209	9 000	3 600	9 000	9 000	3 250	203	±4.2
229	8 300	3 300	8 300	8 300	3 250	203	±3.9
255	7 400	2 900	7 400	7 400	3 250	203	±3.6
280	6 800	2 700	6 800	6 800	3 250	203	±3.4
300	6 300	2 500	6 300	6 300	3 250	203	±3.1
330	5 700	2 300	5 700	5 700	3 250	203	±2.9
350	5 400	2 100	5 400	5 400	3 250	203	±2.8
413	4 600	1 840	4 600	4 600	3 250	203	±2.4
417	4 500	1 800	4 500	4 500	3 250	203	±2.4
489	3 900	1 500	3 900	3 900	3 250	203	±2.1
550	3 400	1 300	3 400	3 400	3 250	203	±1.9

CAUTION: Very high speed motion axes require additional design consideration. For applications that will exceed 50% of the rated maximum reading speed of the ring, contact your local Renishaw representative.

For REXA30 speed and accuracy figures, refer to the *REXA30 ultra-high accuracy absolute angle encoder* data sheet (Renishaw part no. L-9517-9405).

¹ 'Typical' installations are a result of graduation and installation errors combining and, to some magnitude, cancelling.

² The maximum speed depends on the driver, motor and mechanical components. Contact Renishaw or Panasonic regarding the maximum speed.

General specifications

		BiSS C (unidirectional), FANUC, Mitsubishi, Panasonic and Yaskawa	Siemens DRIVE-CLiQ
Power supply		5 V ±10% 1.25 W maximum (250 mA @ 5 V) ¹ Ripple: 200 mVpp maximum @ frequency up to 500 kHz maximum	Single readhead system: 3.05 W maximum (readhead: 1.25 W + single input interface: 1.8 W). Dual readhead system: 4.3 W maximum (2 × readheads: 1.25 W each + dual input interface: 1.8 W). 24 V power is provided by the DRIVE-CLiQ network. Ripple: 200 mVpp maximum @ frequency up to 500 kHz maximum
Temperature	Storage	-20 °C to 80 °C	-20 °C to 70 °C
	Installation	+20 °C ±5 °C	+20 °C ±5 °C
	Operating	0 °C to +80 °C	0 °C to +80 °C (readhead) 0 °C to +55 °C (interface)
Humidity		95% relative humidity (non-condensing) to IEC 60068-2-78	
Sealing		IP64	IP64 (readhead) IP67 (interface)
Acceleration	Operating	500 m/s ² , 3 axes (readhead only)	
Maximum acceleration of scale with respect to readhead ²		2000 m/s ²	
Vibration	Operating	300 m/s ² , 55 Hz to 2000 Hz, 3 axes	300 m/s ² , 55 Hz to 2000 Hz, 3 axes (readhead) 100 m/s ² , 55 Hz to 2000 Hz, 3 axes (interface)
Shock	Non-operating	1000 m/s ² , 6 ms, ½ sine, 3 axes	500 m/s ² , 11 ms, ½ sine, 3 axes
Mass	Readhead	18 g	18 g
	Readhead cable	32 g/m	32 g/m
	Interface	-	218 g
EMC compliance		IEC 61800-5-2 Annex E	
Readhead cable		7 core, tinned and annealed copper, 28 AWG Single-shielded, outside diameter 4.7 ±0.2 mm Flex life > 40 × 10 ⁶ cycles at 20 mm bend radius UL recognised component 	
Maximum readhead cable length		10 m	10 m (to controller or interface) (refer to Siemens DRIVE-CLiQ specifications for maximum cable length from interface to controller)

CAUTION: The RESOLUTE encoder system has been designed to the relevant EMC standards, but must be correctly integrated to achieve EMC compliance. In particular, attention to shielding arrangements is essential.

NOTE: For Extended Temperature Range (ETR), Ultra-high vacuum (UHV), and Functional Safety RESOLUTE readhead specifications refer to the relevant data sheets which can be downloaded from www.renishaw.com/resolutedownloads.

¹ Current consumption figures refer to terminated RESOLUTE systems. Renishaw encoder systems must be powered from a 5 Vdc supply complying with the requirements for SELV of standard IEC 60950-1.

² This is the worst case figure that is correct for the slowest communications clock rates. For faster clock rates, the maximum acceleration of scale with respect to the readhead can be higher. For more details, contact your local Renishaw representative.

RESOLUTE readhead installation drawing

Dimensions and tolerances in mm

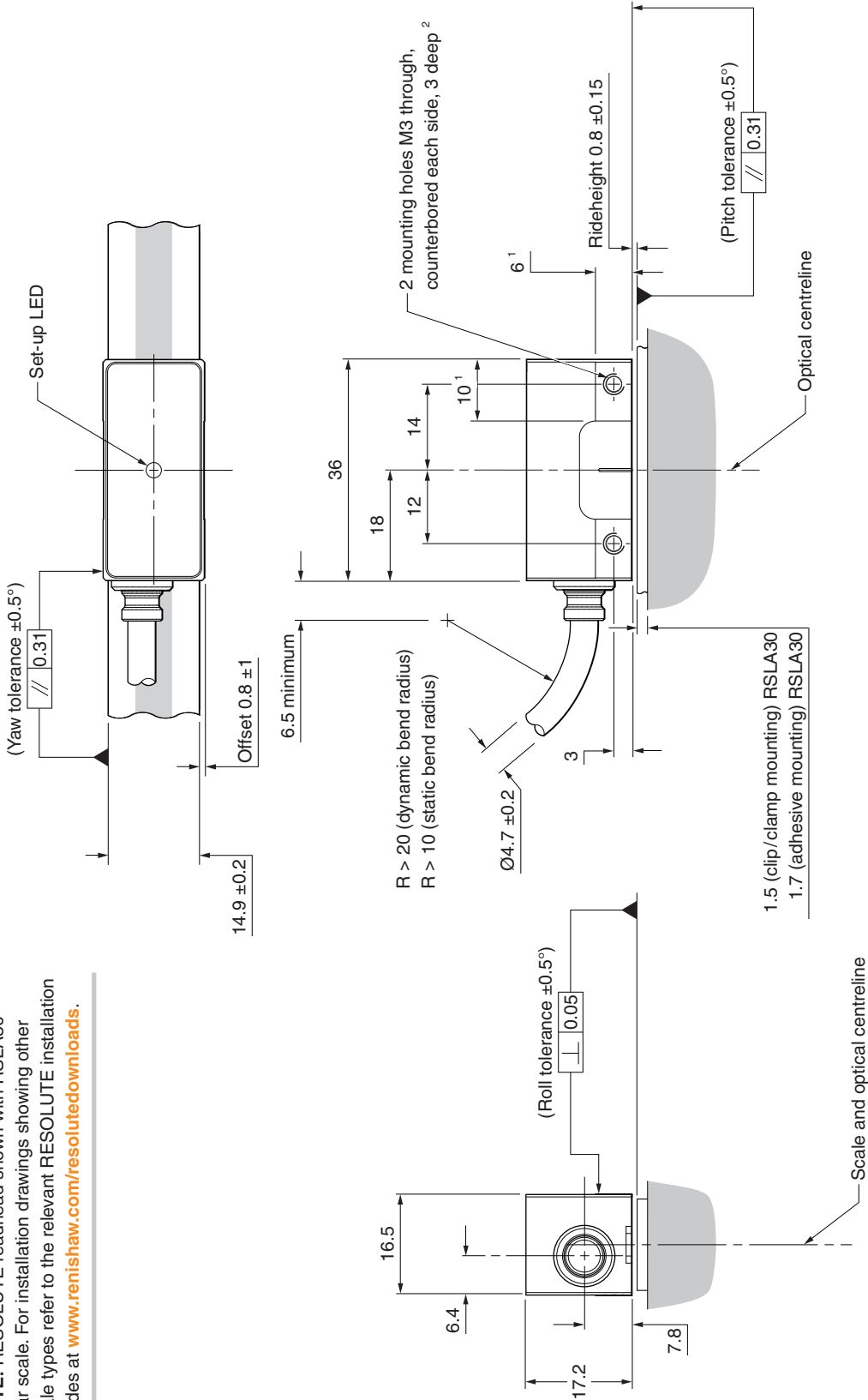

¹ Extent of mounting faces.

² The recommended thread engagement is 5 mm minimum (8 mm including counterbore) and the recommended tightening torque is 0.5 Nm to 0.7 Nm.

RESOLUTE side exit cable readhead installation drawing

Dimensions and tolerances in mm

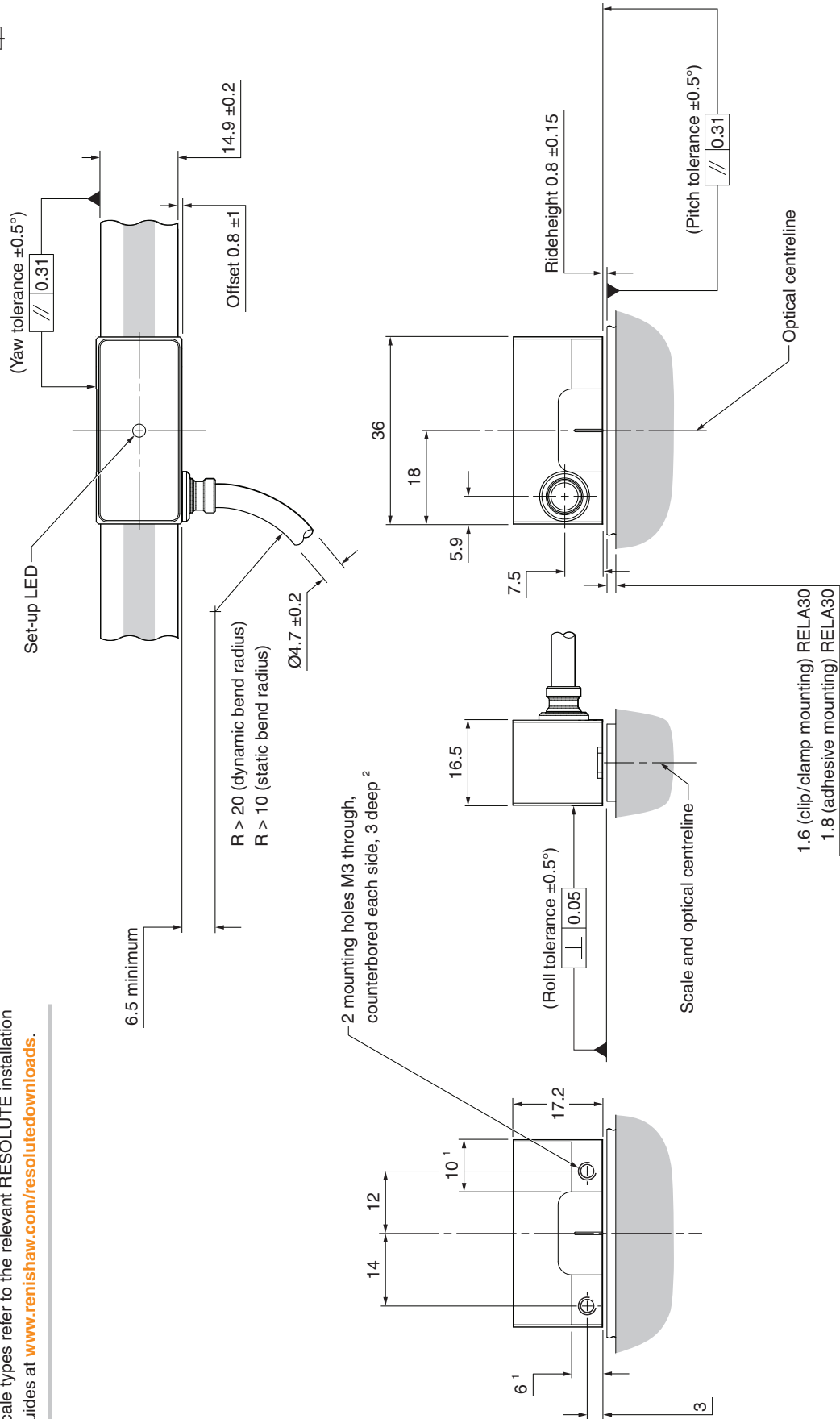

NOTE: RESOLUTE readhead shown with RELA30 spar scale. For installation drawings showing other scale types refer to the relevant RESOLUTE installation guides at www.renishaw.com/resolutedownloads.

¹ Extent of mounting faces.
² The recommended thread engagement is 5 mm minimum (8 mm including counterbore) and the recommended tightening torque is 0.5 Nm to 0.7 Nm.

Siemens DRIVE-CLiQ interface drawing

Dimensions and tolerances in mm



Single readhead input (A-9796-0575)

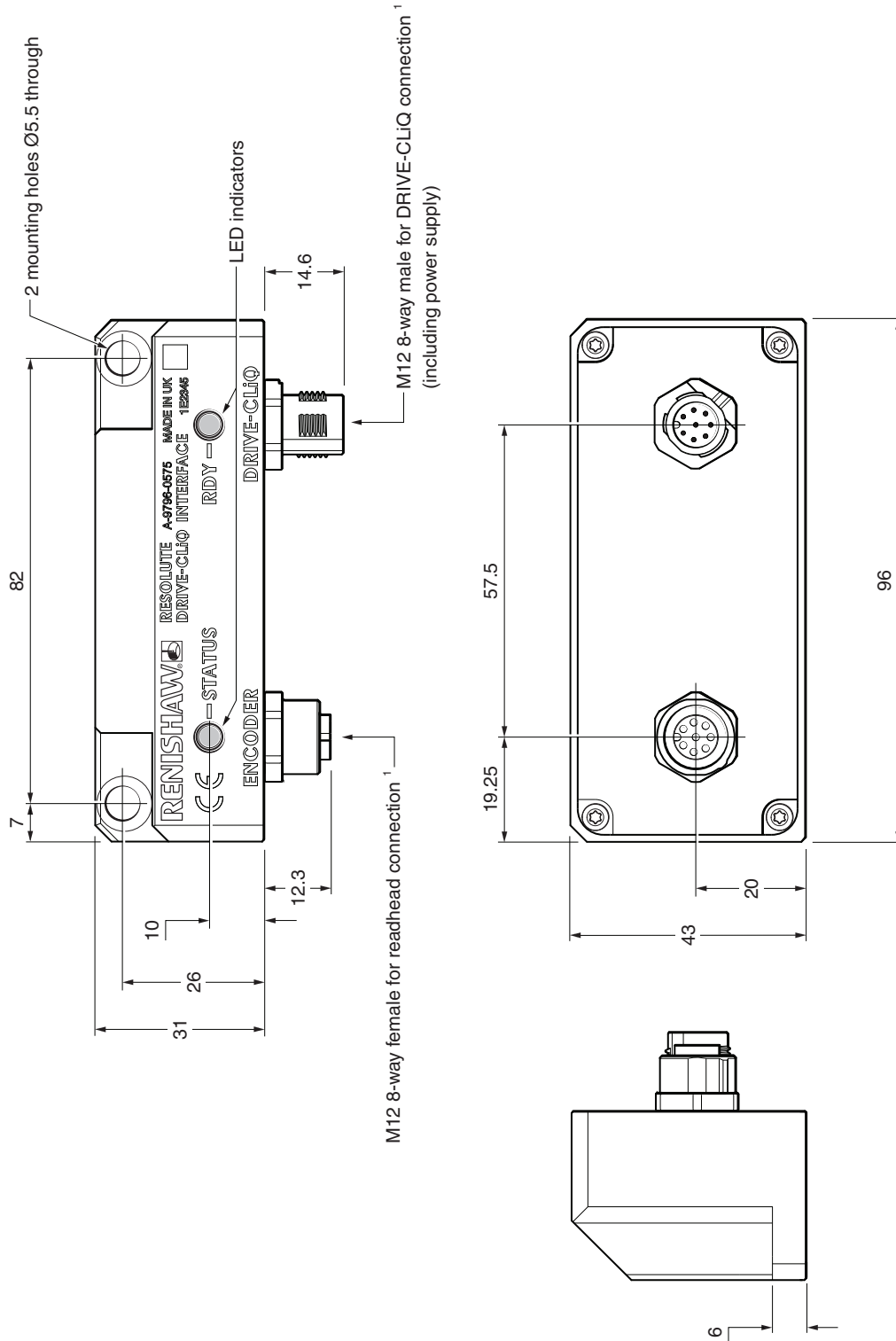

¹ Maximum tightening torque 4 Nm.

Siemens DRIVE-CLiQ interface drawing

Dimensions and tolerances in mm



Dual readhead input (A-9796-0590)

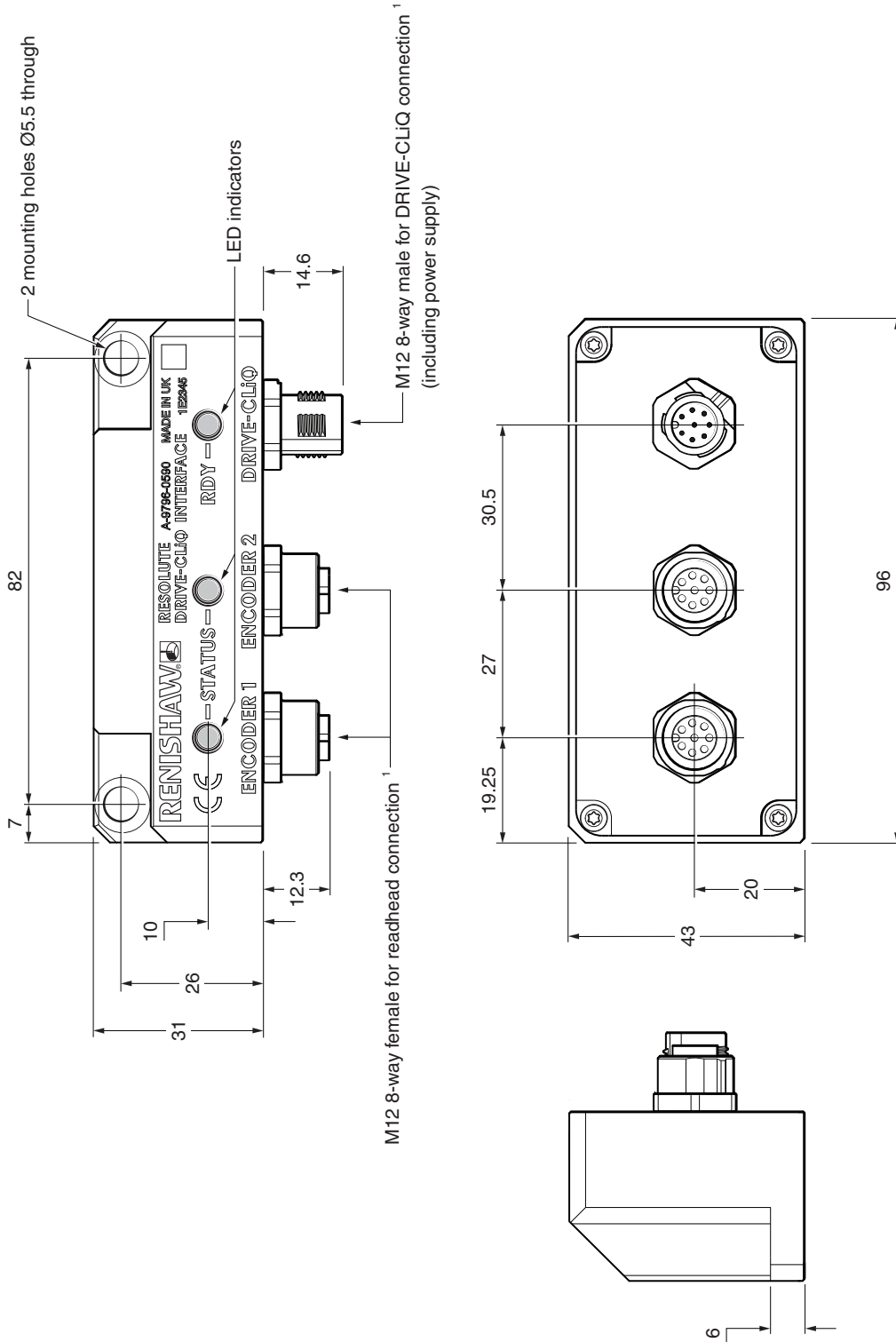

¹ Maximum tightening torque 4 Nm.

RESOLUTE BiSS readhead part numbers

Linear and partial arc readheads

R L 32B B T 001 E 30 A

Series _____

R = RESOLUTE

Scale form _____

L = Linear/partial arc

Serial interface _____

26B = BiSS 26 bit

32B = BiSS 32 bit

36B = BiSS 36 bit

Mechanical option _____

B = Standard cable outlet

R = Side cable outlet

Gain option _____

T = RTLA30 / RTLA30-S / RKLA30-S

S = RSLA30

E = RELA30

Resolution _____

001 = 1 nm

005 = 5 nm

050 = 50 nm

Scale code option¹ _____

B = RTLA30 / RTLA30-S / RKLA30-S (20 mm to 10 m scale length)

C = RSLA30 (20 mm to 5 m scale length) / RELA30 (> 1.13 m to 1.5 m scale length)

D = RELA30 (20 mm to 1.13 m scale length)

E = RTLA30 / RTLA30-S / RKLA30-S (> 10 m to 21 m scale length)

Cable length _____

02 = 0.2 metres

15 = 1.5 metres

90 = 9.0 metres

05 = 0.5 metres

30 = 3.0 metres

99 = 10.0 metres

10 = 1.0 metres

50 = 5.0 metres

Cable termination _____

A = 9-way D-type connector

F = Flying lead (unterminated cable)

L = LEMO in-line connector

S = M12 (sealed) connector

For RESOLUTE BiSS UHV and Functional Safety linear readhead part numbers see the relevant data sheet at www.renishaw.com/resolutedownloads.

Valid system configurations (readheads and scale) can be checked at www.renishaw.com/epc.

¹ The maximum scale length may be limited for some serial interfaces and resolutions; refer to 'Resolution and scale lengths' on page 7 for details.

RESOLUTE BiSS readhead part numbers

Rotary readheads

R A 32B B A 052 B 30 A

Series

R = RESOLUTE

Scale form

A = Angular

Serial interface

18B = BiSS 18 bit

26B = BiSS 26 bit

32B = BiSS 32 bit

Mechanical option

B = Standard cable outlet

R = Side cable outlet

Gain option

A = Standard

Ring diameter

052 = 52 mm	150 = 150 mm	280 = 280 mm (RESA30 only)
057 = 57 mm	165 = 165 mm	300 = 300 mm
075 = 75 mm	172 = 172 mm	330 = 330 mm (RESA30 only)
100 = 100 mm	183 = 183 mm	350 = 350 mm
101 = 101 mm (RESA30 only)	200 = 200 mm	413 = 413 mm (RESA30 only)
103 = 103 mm	206 = 206 mm	417 = 417 mm
104 = 104 mm	209 = 209 mm	489 = 489 mm (RESA30 only)
115 = 115 mm	229 = 229 mm	550 = 550 mm (RESA30 only)
124 = 124 mm (RESA30 only)	255 = 255 mm	

Scale code option

B = Standard scale code

Cable length

02 = 0.2 metres	15 = 1.5 metres	90 = 9.0 metres
05 = 0.5 metres	30 = 3.0 metres	99 = 10.0 metres
10 = 1.0 metres	50 = 5.0 metres	

Cable termination

A = 9-way D-type connector

F = Flying lead (unterminated cable)

L = LEMO in-line connector

S = M12 (sealed) connector

For RESOLUTE BiSS ETR, UHV and Functional Safety linear readhead part numbers see the relevant data sheet at www.renishaw.com/resolutedownloads.

Valid system configurations (readheads and scale) can be checked at www.renishaw.com/epc.

RESOLUTE FANUC readhead part numbers

Linear and partial arc readheads

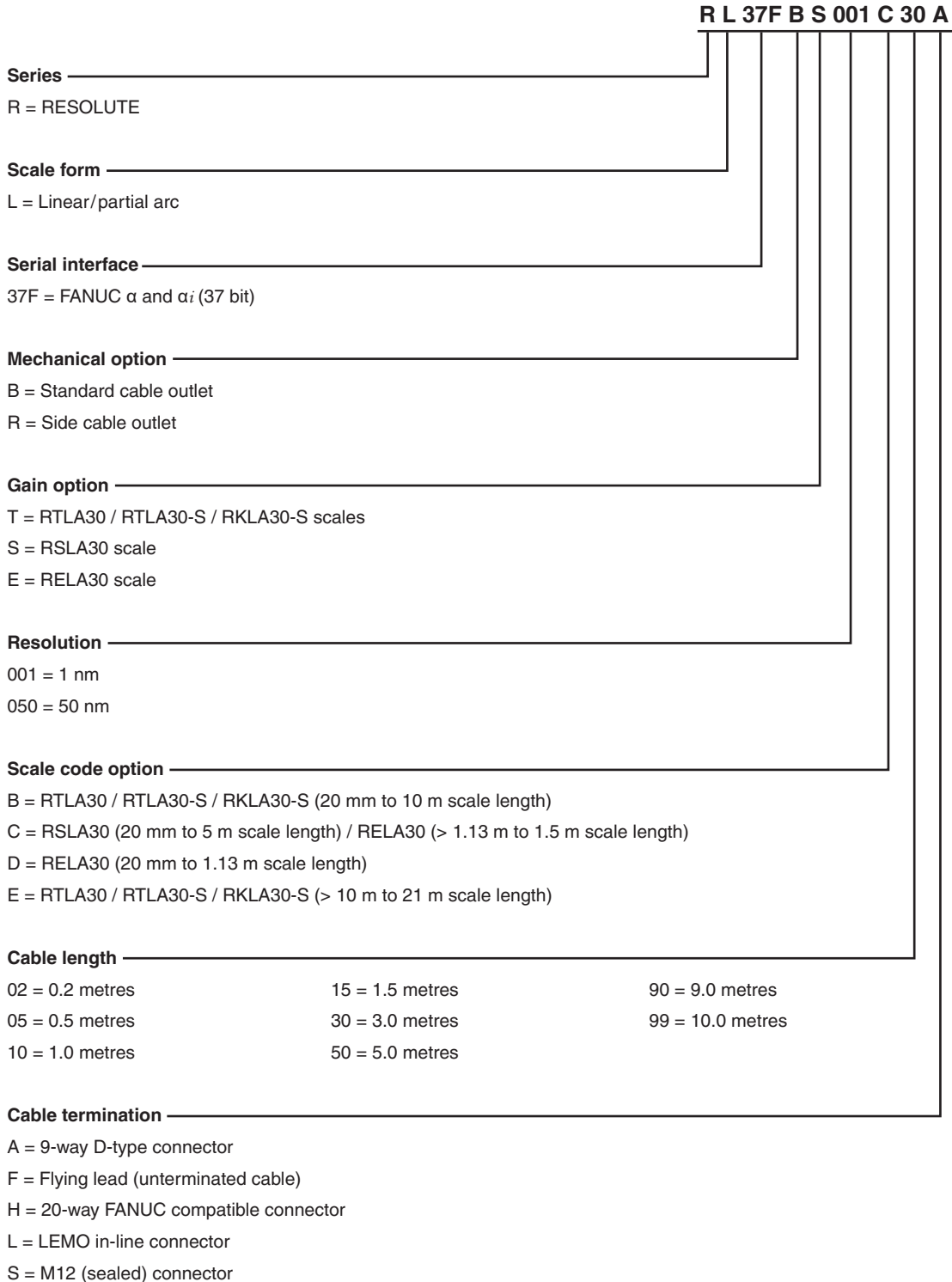

Valid system configurations (readheads and scale) can be checked at www.renishaw.com/epc.

RESOLUTE FANUC readhead part numbers

Rotary readheads

R A 27F B A 052 B 30 A

Series _____

R = RESOLUTE

Scale form _____

A = Angular

Serial interface _____

27F = FANUC α High Type B and α_i (27 bit)

31F = FANUC α_i (31 bit)

Mechanical option _____

B = Standard cable outlet

R = Side cable outlet

Gain option _____

A = Standard

Ring diameter _____

052 = 52 mm	150 = 150 mm	280 = 280 mm (RESA30 only)
057 = 57 mm	165 = 165 mm	300 = 300 mm
075 = 75 mm	172 = 172 mm	330 = 330 mm (RESA30 only)
100 = 100 mm	183 = 183 mm	350 = 350 mm
101 = 101 mm (RESA30 only)	200 = 200 mm	413 = 413 mm (RESA30 only)
103 = 103 mm	206 = 206 mm	417 = 417 mm
104 = 104 mm	209 = 209 mm	489 = 489 mm (RESA30 only)
115 = 115 mm	229 = 229 mm	550 = 550 mm (RESA30 only)
124 = 124 mm (RESA30 only)	255 = 255 mm	

Scale code option _____

B = Standard scale code

Cable length _____

02 = 0.2 metres	15 = 1.5 metres	90 = 9.0 metres
05 = 0.5 metres	30 = 3.0 metres	99 = 10.0 metres
10 = 1.0 metres	50 = 5.0 metres	

Cable termination _____

A = 9-way D-type connector

F = Flying lead (unterminated cable)

H = 20-way FANUC compatible connector

L = LEMO in-line connector

S = M12 (sealed) connector

Valid system configurations (readheads and scale) can be checked at www.renishaw.com/epc.

RESOLUTE Mitsubishi readhead part numbers

Linear and partial arc readheads

R L 40M B S 001 C 30 N

Series _____

R = RESOLUTE

Scale form _____

L = Linear/partial arc

Serial interface _____

40M = Mitsubishi 40 bit, 2 wire ¹

40N = Mitsubishi 40 bit, 4 wire ¹

Mechanical option _____

B = Standard cable outlet

R = Side cable outlet

Gain option _____

T = RTLA30 / RTLA30-S / RKLA30-S scales

S = RSLA30 scale

E = RELA30 scale

Resolution _____

001 = 1 nm

050 = 50 nm

Scale code option _____

B = RTLA30 / RTLA30-S / RKLA30-S (20 mm to 10 m scale length)

C = RSLA30 (20 mm to 5 m scale length) / RELA30 (> 1.13 m to 1.5 m scale length)

D = RELA30 (20 mm to 1.13 m scale length)

E = RTLA30 / RTLA30-S / RKLA30-S (> 10 m to 21 m scale length)

Cable length _____

02 = 0.2 metres

15 = 1.5 metres

90 = 9.0 metres

05 = 0.5 metres

30 = 3.0 metres

99 = 10.0 metres

10 = 1.0 metres

50 = 5.0 metres

Cable termination _____

A = 9-way D-type connector

F = Flying lead (unterminated cable)

L = LEMO in-line connector

N = 15-way D-type connector for Mitsubishi

P = 10-way Mitsubishi connector

For more information about Mitsubishi drives, contact Mitsubishi.

Valid system configurations (readheads and scale) can be checked at www.renishaw.com/epc.

¹ 2 wire: MR-J4 series/MR-J5 series

4 wire: MDS-D2/DH2/DM2/DJ

RESOLUTE Mitsubishi readhead part numbers

Rotary readheads

R A 23M B A 052 B 30 N

Series _____

R = RESOLUTE

Scale form _____

A = Angular

Serial interface _____

23M = Mitsubishi 23 bit, 2 wire ¹

23N = Mitsubishi 23 bit, 4 wire ²

27N = Mitsubishi 27 bit, 4 wire ²

Mechanical option _____

B = Standard cable outlet

R = Side cable outlet

Gain option _____

A = Standard

Ring diameter _____

052 = 52 mm	150 = 150 mm	280 = 280 mm (RESA30 only)
057 = 57 mm	165 = 165 mm	300 = 300 mm
075 = 75 mm	172 = 172 mm	330 = 330 mm (RESA30 only)
100 = 100 mm	183 = 183 mm	350 = 350 mm
101 = 101 mm (RESA30 only)	200 = 200 mm	413 = 413 mm (RESA30 only)
103 = 103 mm	206 = 206 mm	417 = 417 mm
104 = 104 mm	209 = 209 mm	489 = 489 mm (RESA30 only)
115 = 115 mm	229 = 229 mm	550 = 550 mm (RESA30 only)
124 = 124 mm (RESA30 only)	255 = 255 mm	

Scale code option _____

B = Standard scale code

Cable length _____

02 = 0.2 metres	15 = 1.5 metres	90 = 9.0 metres
05 = 0.5 metres	30 = 3.0 metres	99 = 10.0 metres
10 = 1.0 metres	50 = 5.0 metres	

Cable termination _____

A = 9-way D-type connector

F = Flying lead (unterminated cable)

L = LEMO in-line connector

N = 15-way D-type connector for Mitsubishi

P = 10-way Mitsubishi connector

For more information about Mitsubishi drives, contact Mitsubishi.

Valid system configurations (readheads and scale) can be checked at www.renishaw.com/epc.

¹ 2 wire: MR-J4 series

² 4 wire: MDS-D2/DH2/DM2/DJ

RESOLUTE Panasonic readhead part numbers

Linear and partial arc readheads

R L 48P B S 001 C 30 A

Series _____

R = RESOLUTE

Scale form _____

L = Linear/partial arc

Serial interface _____

48P = Panasonic 48 bit

Mechanical option _____

B = Standard cable outlet

R = Side cable outlet

Gain option _____

T = RTLA30 / RTLA30-S / RKLA30-S scales

S = RSLA30 scale

E = RELA30 scale

Resolution _____

001 = 1 nm

050 = 50 nm

100 = 100 nm

Scale code option _____

B = RTLA30 / RTLA30-S / RKLA30-S (20 mm to 10 m scale length)

C = RSLA30 (20 mm to 5 m scale length) / RELA30 (> 1.13 m to 1.5 m scale length)

D = RELA30 (20 mm to 1.13 m scale length)

E = RTLA30 / RTLA30-S / RKLA30-S (> 10 m to 21 m scale length)

Cable length _____

02 = 0.2 metres

15 = 1.5 metres

90 = 9.0 metres

05 = 0.5 metres

30 = 3.0 metres

99 = 10.0 metres

10 = 1.0 metres

50 = 5.0 metres

Cable termination _____

A = 9-way D-type connector

F = Flying lead (unterminated cable)

L = LEMO in-line connector

S = M12 (sealed) connector

For the part numbers of the RESOLUTE Panasonic UHV variant, refer to the *RESOLUTE™ UHV absolute optical encoder* data sheet (Renishaw part no. L-9517-9530), which can be downloaded from www.renishaw.com/resolutedownloads.

Valid system configurations (readheads and scale) can be checked at www.renishaw.com/epc.

RESOLUTE Panasonic readhead part numbers

Rotary readheads

R A 23P B A 052 B 30 A

Series _____

R = RESOLUTE

Scale form _____

A = Angular

Serial interface _____

23P = Panasonic 23 bit
32P = Panasonic 32 bit

Mechanical option _____

B = Standard cable outlet
R = Side cable outlet

Gain option _____

A = Standard

Ring diameter _____

052 = 52 mm	150 = 150 mm	280 = 280 mm (RESA30 only)
057 = 57 mm	165 = 165 mm	300 = 300 mm
075 = 75 mm	172 = 172 mm	330 = 330 mm (RESA30 only)
100 = 100 mm	183 = 183 mm	350 = 350 mm
101 = 101 mm (RESA30 only)	200 = 200 mm	413 = 413 mm (RESA30 only)
103 = 103 mm	206 = 206 mm	417 = 417 mm
104 = 104 mm	209 = 209 mm	489 = 489 mm (RESA30 only)
115 = 115 mm	229 = 229 mm	550 = 550 mm (RESA30 only)
124 = 124 mm (RESA30 only)	255 = 255 mm	

Scale code option _____

B = Standard scale code

Cable length _____

02 = 0.2 metres	15 = 1.5 metres	90 = 9.0 metres
05 = 0.5 metres	30 = 3.0 metres	99 = 10.0 metres
10 = 1.0 metres	50 = 5.0 metres	

Cable termination _____

A = 9-way D-type connector
F = Flying lead (unterminated cable)
L = LEMO in-line connector
S = M12 (sealed) connector

For the part numbers of the RESOLUTE Panasonic UHV variant, refer to the *RESOLUTE™ UHV absolute optical encoder* data sheet (Renishaw part no. L-9517-9530), which can be downloaded from www.renishaw.com/resolutedownloads.

Valid system configurations (readheads and scale) can be checked at www.renishaw.com/epc.

RESOLUTE Siemens DRIVE-CLiQ readhead part numbers

Linear and partial arc readheads

R L 34D B S 001 C 30 S

Series _____

R = RESOLUTE

Scale form _____

L = Linear/partial arc

Serial interface _____

28D = Siemens DRIVE-CLiQ 28 bit (for 50 nm resolution) ¹

34D = Siemens DRIVE-CLiQ 34 bit (for 1 nm resolution) ¹

Mechanical option _____

B = Standard cable outlet

R = Side cable outlet

Gain option _____

T = RTLA30 / RTLA30-S / RKLA30-S scales

S = RSLA30 scale

E = RELA30 scale

Resolution _____

001 = 1 nm

050 = 50 nm

Scale code option ² _____

B = RTLA30 / RTLA30-S / RKLA30-S (20 mm to 10 m scale length)

C = RSLA30 (20 mm to 5 m scale length) / RELA30 (> 1.13 m to 1.5 m scale length)

D = RELA30 (20 mm to 1.13 m scale length)

E = RTLA30 / RTLA30-S / RKLA30-S (> 10 m to 21 m scale length)

Cable length _____

02 = 0.2 metres

15 = 1.5 metres

90 = 9.0 metres

05 = 0.5 metres

30 = 3.0 metres

99 = 10.0 metres

10 = 1.0 metres

50 = 5.0 metres

Cable termination _____

F = Flying lead (unterminated cable)

S = M12 (sealed) connector

For the part numbers of the RESOLUTE Siemens DRIVE-CLiQ Functional Safety variant, refer to the *RESOLUTE™ Functional Safety absolute optical encoder system* data sheet (Renishaw part no. L-9518-0020), which can be downloaded from www.renishaw.com/resolutedownloads.

Valid system configurations (readheads and scale) can be checked at www.renishaw.com/epc.

¹ For linear Siemens DRIVE-CLiQ variants 'Serial interface' and 'Resolution' must be selected in certain combinations.

- 28D must be selected for 50 nm resolution systems.
- 34D must be selected for 1nm resolution systems.

Other combinations are not valid.

² The maximum scale length may be limited for some serial interfaces and resolutions; refer to 'Resolution and scale lengths' on page 7 for details.

RESOLUTE Siemens DRIVE-CLiQ readhead part numbers

Rotary readheads

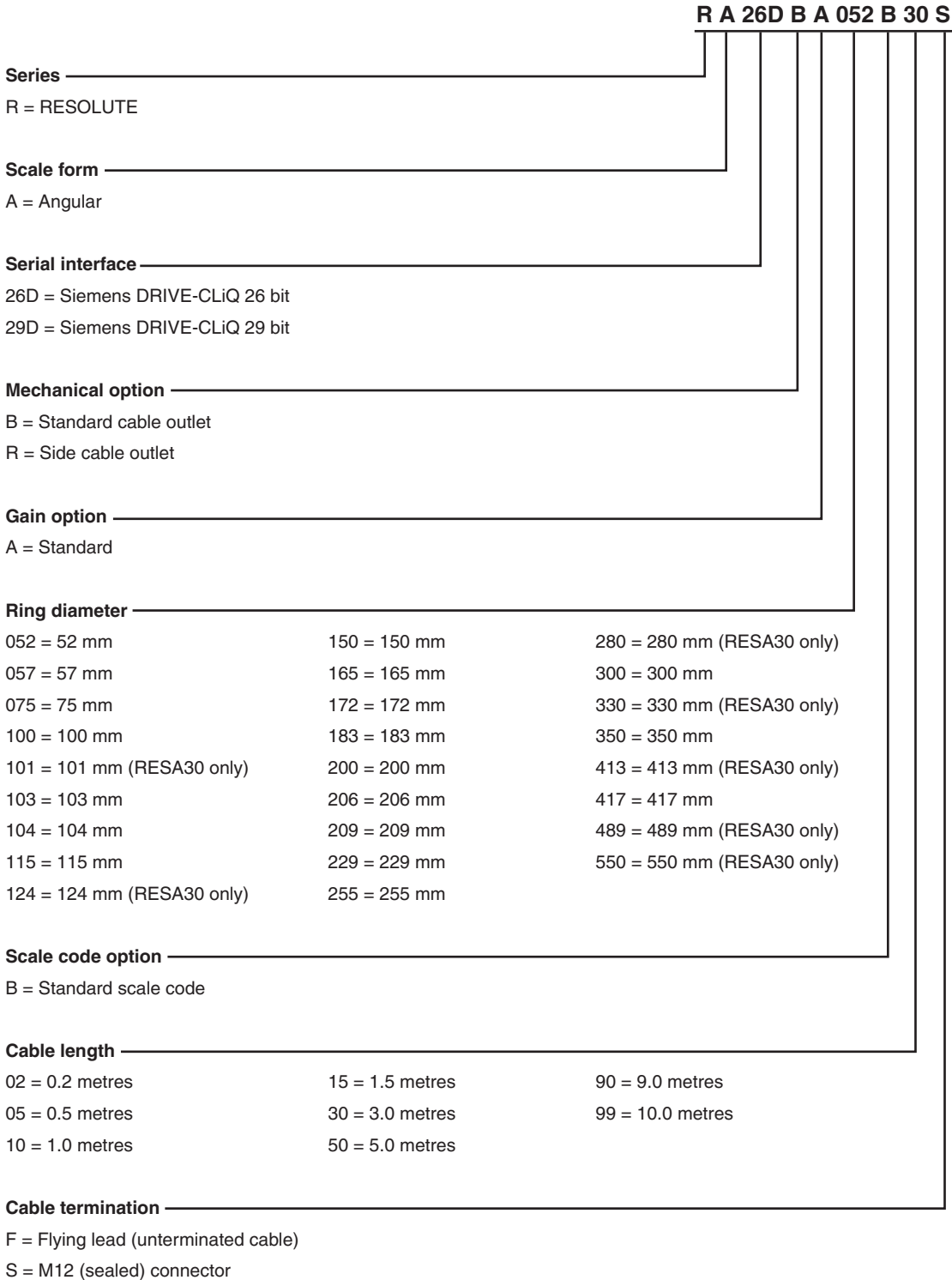

For the part numbers of the RESOLUTE Siemens DRIVE-CLiQ Functional Safety variant, refer to the *RESOLUTE™ Functional Safety absolute optical encoder system* data sheet (Renishaw part no. L-9518-0020), which can be downloaded from www.renishaw.com/resolutedownloads.

Valid system configurations (readheads and scale) can be checked at www.renishaw.com/epc.

RESOLUTE Yaskawa readhead part numbers

Linear and partial arc readheads

R L 36Y B S 001 C 30 A

Series _____

R = RESOLUTE

Scale form _____

L = Linear/partial arc

Serial interface _____

36Y = Yaskawa 36 bit

Mechanical option _____

B = Standard cable outlet

R = Side cable outlet

Gain option _____

T = RTLA30 / RTLA30-S / RKLA30-S scales

S = RSLA30 scale

E = RELA30 scale

Resolution _____

001 = 1 nm

050 = 50 nm

Scale code option¹ _____

B = RTLA30 / RTLA30-S / RKLA30-S (20 mm to 10 m scale length)

C = RSLA30 (20 mm to 5 m scale length) / RELA30 (> 1.13 m to 1.5 m scale length)

D = RELA30 (20 mm to 1.13 m scale length)

E = RTLA30 / RTLA30-S / RKLA30-S (> 10 m to 21 m scale length)

Cable length _____

02 = 0.2 metres

15 = 1.5 metres

90 = 9.0 metres

05 = 0.5 metres

30 = 3.0 metres

99 = 10.0 metres

10 = 1.0 metres

50 = 5.0 metres

Cable termination _____

A = 9-way D-type connector

F = Flying lead (unterminated cable)

L = LEMO in-line connector

S = M12 (sealed) connector

Valid system configurations (readheads and scale) can be checked at www.renishaw.com/epc.

¹ The maximum scale length may be limited for some serial interfaces and resolutions; refer to 'Resolution and scale lengths' on page 7 for details.

RESOLUTE Yaskawa readhead part numbers

Rotary readheads

R A 24Y B A 052 B 30 A

Series

R = RESOLUTE

Scale form

A = Angular

Serial interface

23Y = Yaskawa 23 bit ¹

24Y = Yaskawa 24 bit ²

26Y = Yaskawa 26 bit ¹

30Y = Yaskawa 30 bit ¹

Mechanical option

B = Standard cable outlet

R = Side cable outlet

Gain option

A = Standard

Ring diameter

052 = 52 mm	150 = 150 mm	280 = 280 mm (RESA30 only)
057 = 57 mm	165 = 165 mm	300 = 300 mm
075 = 75 mm	172 = 172 mm	330 = 330 mm (RESA30 only)
100 = 100 mm	183 = 183 mm	350 = 350 mm
101 = 101 mm (RESA30 only)	200 = 200 mm	413 = 413 mm (RESA30 only)
103 = 103 mm	206 = 206 mm	417 = 417 mm
104 = 104 mm	209 = 209 mm	489 = 489 mm (RESA30 only)
115 = 115 mm	229 = 229 mm	550 = 550 mm (RESA30 only)
124 = 124 mm (RESA30 only)	255 = 255 mm	

Scale code option

B = Standard scale code

Cable length

02 = 0.2 metres	15 = 1.5 metres	90 = 9.0 metres
05 = 0.5 metres	30 = 3.0 metres	99 = 10.0 metres
10 = 1.0 metres	50 = 5.0 metres	

Cable termination

A = 9-way D-type connector

F = Flying lead (unterminated cable)

L = LEMO in-line connector

S = M12 (sealed) connector

¹ For fully-closed loop control.

² For rotary servomotors.

Valid system configurations (readheads and scale) can be checked at www.renishaw.com/epc.

RESOLUTE series compatible products

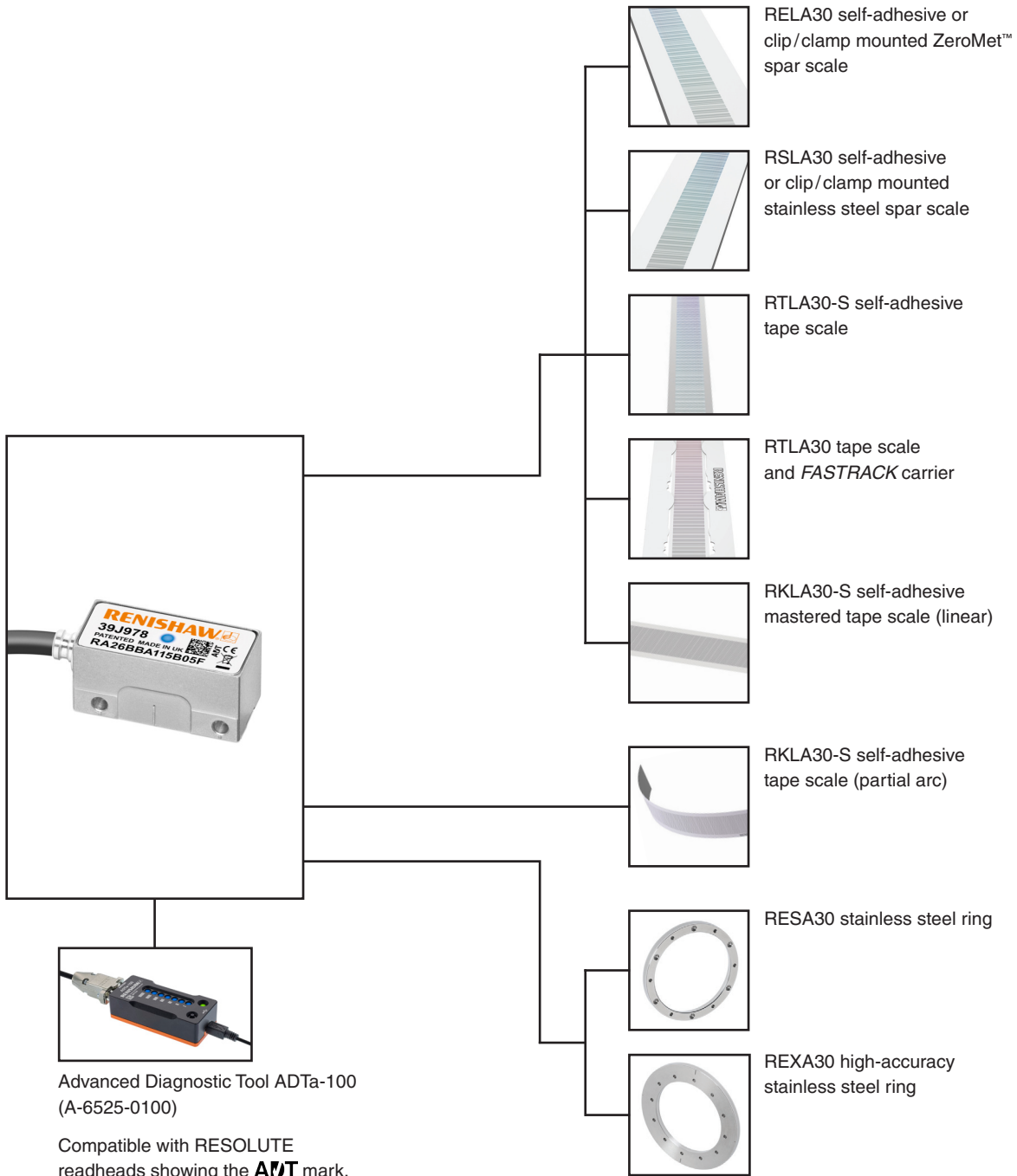

For more information about the ADTa-100 and the scale, refer to the relevant data sheets and installation guides which can be downloaded from www.renishaw.com/resolutedownloads.

www.renishaw.com/contact

 #renishaw

+44 (0) 1453 524524

 uk@renishaw.com

© 2010–2024 Renishaw plc. All rights reserved. This document may not be copied or reproduced in whole or in part, or transferred to any other media or language by any means, without the prior written permission of Renishaw.
RENISHAW® and the probe symbol are registered trade marks of Renishaw plc. Renishaw product names, designations and the mark 'apply innovation' are trade marks of Renishaw plc or its subsidiaries. BiSS® is a registered trademark of iC-Haus GmbH. DRIVE-CLiQ is a registered trademark of Siemens. Other brand, product or company names are trade marks of their respective owners.
WHILE CONSIDERABLE EFFORT WAS MADE TO VERIFY THE ACCURACY OF THIS DOCUMENT AT PUBLICATION, ALL WARRANTIES, CONDITIONS, REPRESENTATIONS AND LIABILITY, HOWSOEVER ARISING, ARE EXCLUDED TO THE EXTENT PERMITTED BY LAW. RENISHAW RESERVES THE RIGHT TO MAKE CHANGES TO THIS DOCUMENT AND TO THE EQUIPMENT, AND/OR SOFTWARE AND THE SPECIFICATION DESCRIBED HEREIN WITHOUT OBLIGATION TO PROVIDE NOTICE OF SUCH CHANGES.
Renishaw plc. Registered in England and Wales. Company no: 1106260. Registered office: New Mills, Wotton-under-Edge, Glos, GL12 8JR, UK.

Part no.: L-9518-0013-01-B

Issued: 04.2024